



BYPASS DOOR
Installation Instructions
For Up to 60 LBS. Door Weight

TOOLS REQUIRED



Kit Contains:

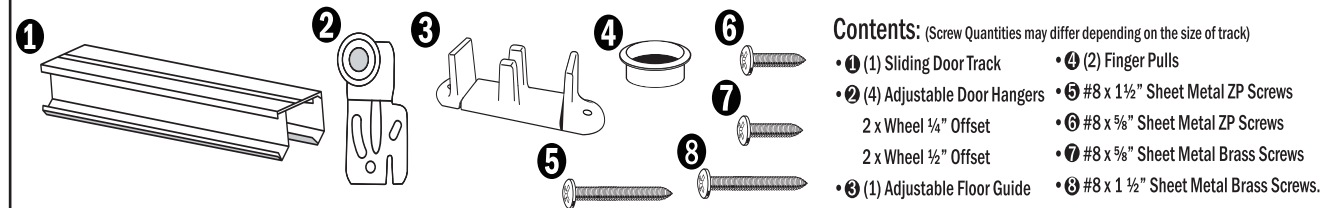

- Contents: (Screw Quantities may differ depending on the size of track)
- 1 Sliding Door Track
 - 2 Finger Pulls
 - 4 Adjustable Door Hangers
 - 2 #8 x 1 1/2" Sheet Metal ZP Screws
 - 2 x Wheel 1/4" Offset
 - 2 #8 x 5/8" Sheet Metal ZP Screws
 - 2 x Wheel 1/2" Offset
 - 2 #8 x 5/8" Sheet Metal Brass Screws
 - 1 Adjustable Floor Guide
 - 2 #8 x 1 1/2" Sheet Metal Brass Screws

Step 1

Measure width and height of finished opening and record it.

Width = _____
Height = _____

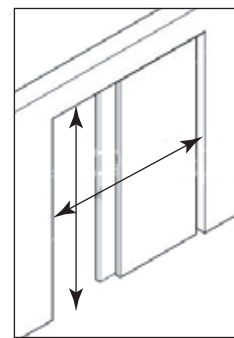

Step 2

Preparing Doors:

Door width is 1/2 the size of finished opening plus 1/2" per panel.
Example: Opening width of 48", each door panel must be 24 1/2" wide.
Door height should be 1 3/4" less than the finished opening height (measured from top of opening to finished floor or top of carpeting).

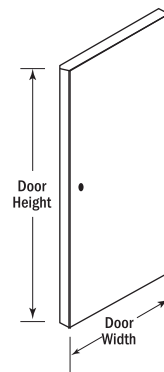

Step 3

Cut galvanized steel track length to at least 1/8" less than the width of the finished opening by using fine tooth blade hacksaw.

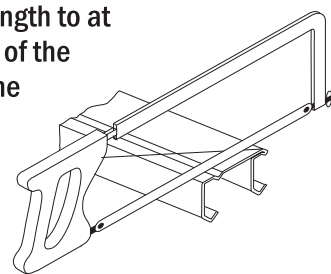

Step 4

Secure the track as illustrated below with fasteners provided and centered between jambs. Use track as a template and mark screw hole locations. Drill 7/64" pilot holes to approximate length of screws

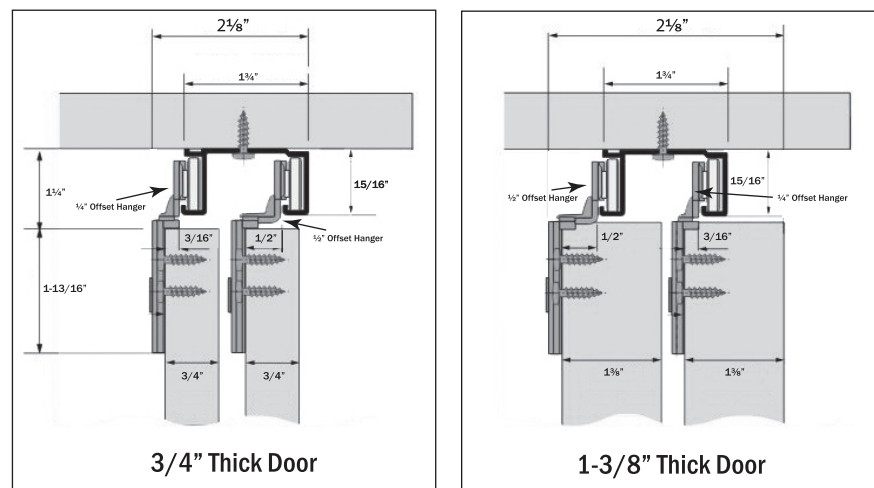

Step 5

Mount Hangers:

- Place Hanger on the back/top door panels using screws provided.
 - Hangers should be 1 1/2" from side of door.
 - Use hanger as a template to mark screw hole locations.
 - Drill 7/64" pilot holes to approximate length of screws.
- * Make sure to install matching hangers on each door panel.

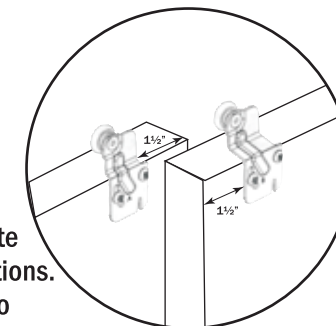

Step 6

Hang Doors on Track

- Hang rear door first by tilting door back and resting hangers on rear rail.
- Repeat for the front door panel on front rail.

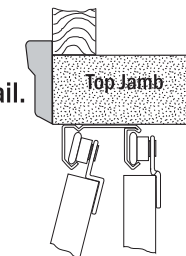

Step 7

Adjusting the Hangers

- To adjust and align doors with jambs, lift door at side near jamb to remove weight of door from hanger.
- Loosen screws and using a slotted screwdriver in the bottom slot, adjust left (raise) or right (lower) for proper alignment.
- Tighten screws.

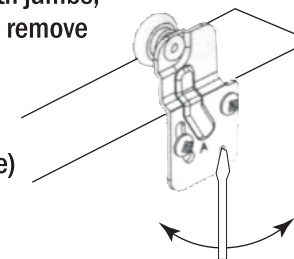

Step 8

Install Floor Guide:

- Remove two end guides
- Secure center guide in the center of the opening on the floor with screws provided.
- Insert two end guides to center guide, making sure the space between two guides fits the door thickness.
- Fasten the end guides with screws provided.

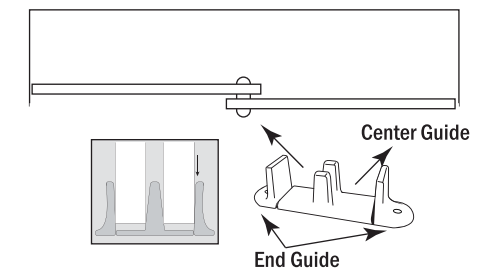

Step 9

Install Finger Pulls:

- Drill a 3/4" hole with 3/8" deep, approximate 40" from the floor and 1-1/2" from the edge on the door panel.
- Depress the pull to the hole.

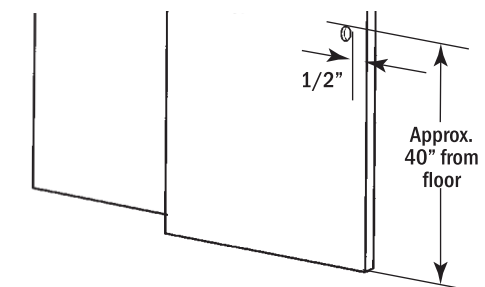

Step 10

If baseboard on the sides of the door opening prevents proper closing, remove the baseboard as needed.

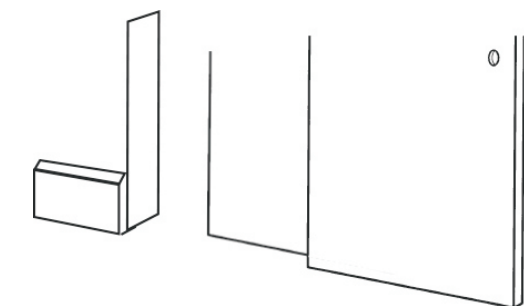

WARNING:
FOLLOW SAFETY
RULES BEFORE USE

Distributed by Orca Hardware
www.orcahardware.com