

ORCA HARDWARE™



PRODUCT CATALOG

Table of Contents

Interior Flat and Round Track Hardware

How to Order.....	4
Flat Track Kits.....	5-7
Hanger Options & Component Parts.....	8-9
Additional Options.....	10
Bypass and Bifold Kits.....	11
Stainless Round Track Kits.....	12
Sliding Door Locks and Pulls.....	13
Component Parts.....	14
Specifications.....	15
Cabinet Flat Track Kits.....	16-17

Interior Pocket & Bypass Track Hardware

Pocket Door Hardware.....	18-20
Bypass Door Hardware	21-25
Bifold Door Hardware.....	26
Parts and Accessories.....	27
Specifications.....	28-29

Bathroom Accessories

Cypress.....	32
Waldron.....	33
Blakely.....	34
Harstine.....	35
Whidbey.....	36
Swirl.....	37
Camano.....	38
Ripple.....	39
Vashon.....	40
Shower Curtain Rods.....	41-42

Door Hinges

Residential Hinges.....	43-46
Commercial Hinges.....	47-49
Spring Hinges.....	50-52
Hinge Specs.....	53

Cabinet Hardware

Bar & Wire Pulls.....	56-57, 65
Knobs & Pulls.....	58-64

Architectural Trim Hardware

Door Trim and Accessories.....	67-78
--------------------------------	-------

Orca Hardware Warranty

Orca Hardware warrants its products manufactured to be free from defects in materials and workmanship for a period of ten (10) years from the date of purchase, except Orca Interior Track Hardware. Orca Hardware warrants its interior track products for two (2) years from the date of purchase.

This limited warranty does not cover products that (i) are not the proper size for the application; (ii) are not installed in accordance with Orca Hardware's published installation instructions; (iii) are installed with improper or incorrect parts [Note: It is recommended that the products be installed with the Orca Hardware fasteners provided with the product]; (iv) have been, in the opinion of Orca Hardware, modified, repaired, or altered in any way without the express written consent of Orca Hardware v) are used for purposes which they are not designed or intended; or (vi) are subjected to misuse, abuse, negligence, or accident. The following costs and expenses are not covered by the provisions of this limited warranty: (i) labor costs for the removal and reinstallation of products; (ii) shipping and freight expenses required to return products to Orca Hardware; (id) normal maintenance; and (iv) economic losses.

Orca Hardware will replace the products which, in the opinion of Orca Hardware, are found to be defective, provided said products are returned to an Orca Hardware Authorized Dealer. Contact your authorized Orca Hardware Distributor at 800-207-2297 for return information.

ORCA HARDWARE SHALL IN NO EVENT BE LIABLE FOR ANY INCIDENTAL, CONSEQUENTIAL, INDIRECT, SPECIAL, OR PUNITIVE DAMAGES FOR ANY CLAIM WHETHER BASED ON CONTRACT, WARRANTY, TORT (INCLUDING, BUT NOT LIMITED TO, STRICT LIABILITY OR NEGLIGENCE), PATENT INFRINGEMENT, OR OTHERWISE, EVEN IF ADVISED OF THE POSSIBILITY OF SUCH DAMAGES.

This limited warranty is in place of all other warranties, expressed or implied, and excludes any warranties of fitness for a particular purpose or merchantability. No agent, representative, dealer, or employee of Orca Hardware has the authority to increase or alter the obligations of this limited warranty.

Note: Should the Product be considered a "consumer product" as may be covered by the Magnuson-Moss Federal Warranty Act, please be advised that. (1) Some states do not allow limitations on incidental or consequential damages or how long an implied warranty lasts, so that the above limitations may not fully apply; and (2) This warranty gives specific legal rights and a user may have other rights which may vary from state to state.

INTERIOR FLAT & ROUND TRACK HARDWARE



POCKET, SLIDING, BYPASS TRACK HARDWARE



GENERAL INFORMATION

<p>APPLICATIONS:</p> <p>Interior Sliding Doors up to 200 lbs. Maximum Door Thickness: 1-3/4" 1 Door Standard 2 Door Option with either a double door kit or extra hangers, stops, guide</p>	<p>FINISHES:</p> <p>Flat Track Black Oil-Rubbed Bronze Satin Stainless Satin Nickel</p> <p>Round Track Stainless Steel</p>	<p>TRACK KITS INCLUDE:</p> <table border="0"> <tr> <td>Track*</td> <td>Connector Plate <i>(for optional use, only in FT Kits)</i></td> </tr> <tr> <td>2 Hangers</td> <td>All Fasteners</td> </tr> <tr> <td>Spacers</td> <td>Door Guides</td> </tr> <tr> <td>End Stops</td> <td>Instructions</td> </tr> <tr> <td>Anti-Jump Blocks <i>(only in Flat Track Kits)</i></td> <td></td> </tr> </table> <p style="text-align: right;">*1 piece except where noted</p>	Track*	Connector Plate <i>(for optional use, only in FT Kits)</i>	2 Hangers	All Fasteners	Spacers	Door Guides	End Stops	Instructions	Anti-Jump Blocks <i>(only in Flat Track Kits)</i>	
Track*	Connector Plate <i>(for optional use, only in FT Kits)</i>											
2 Hangers	All Fasteners											
Spacers	Door Guides											
End Stops	Instructions											
Anti-Jump Blocks <i>(only in Flat Track Kits)</i>												

HOW TO ORDER COMMON APPLICATIONS

Doors not included.

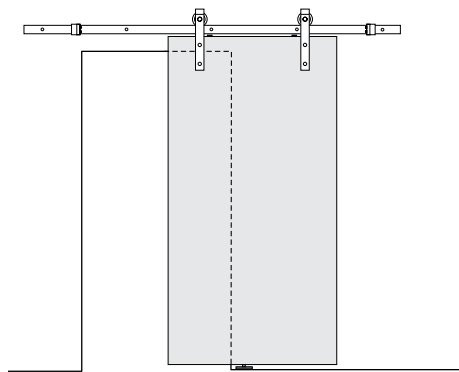

Single Door Covers Opening
Order 1 Complete Kit

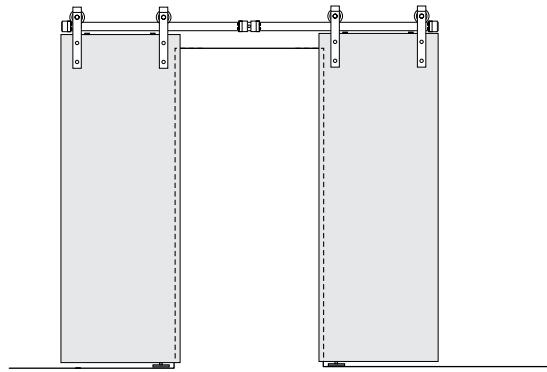

Two Doors Covers Opening
Order 1 Complete Kit & 1 Double Door Kit

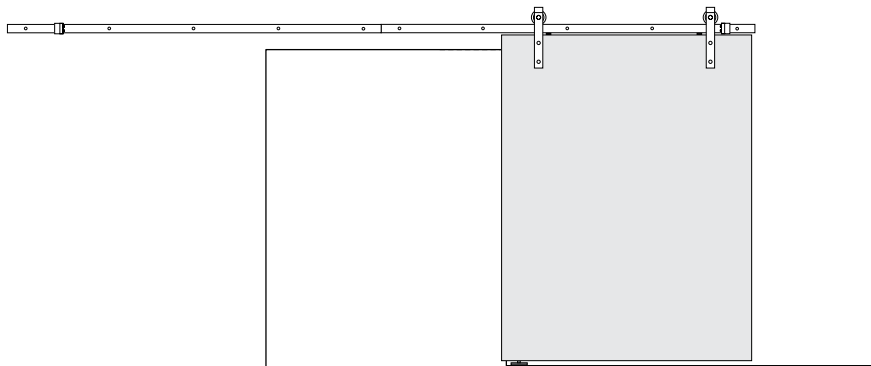

Single Door Covering A Wide Opening
Order 2 Complete Kits

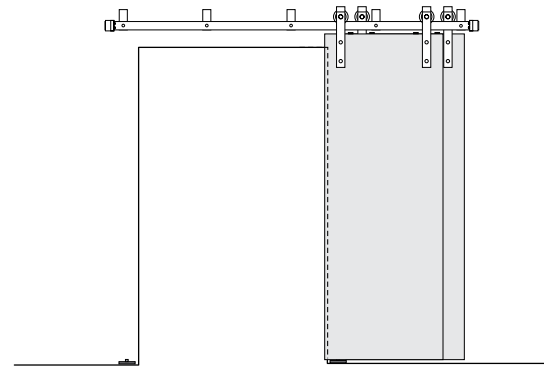

Two Doors Covers Opening as Bypass
Order 2 Complete Kits & Bypass Brackets

More Ordering Examples

Order Standard Kit + order parts shown above

Example 1: Single Door with Softclose: Order 1 Complete Kit and Soft Close Adapter

Example 2: 2 Doors on single 8' Round Track: Order 1 8' Complete Kit, 2 hangers, 2 stops, 1 guide, 1 connector

Example 3: Horseshoe (or Spear) Hangers: Order FTST Complete Kit plus 2 Horseshoe Hangers

- Polymer Wheels for quiet operation
- 200 lbs per Door
- 5', 6', 6'-6", 8' & 10' Options
- For Interior 1-3/8" or 1-3/4" Thick Doors
- All Fasteners Included, including optional connector plate
- Additional Options for: Soft Close & Soft Open, Double Door Applications, & Bypass Applications



PART NO.	DESCRIPTION	
FTST-BL-5	5' Black Flat Track Kit	
FTST-BL-6	6' Black Flat Track Kit	
FTST-BL-78	6' 6" Black Flat Track Kit	
FTST-BL-8	8' Black Flat Track Kit	
FTST-OB-6	6' Oil-Rubbed Bronze Flat Track Kit	KITS CONTAIN: Track (40mm H x 6mm W), Traditional Hangers, Spacers, End Stops, Floor Guides, Anti-Jump Blocks, Track Connector, and all Necessary Fasteners
FTST-OB-8	8' Oil-Rubbed Bronze Flat Track Kit	
FTST-SS-6	6' Satin Stainless Flat Track Kit	
FTST-SS-8	8' Satin Stainless Flat Track Kit	
FTST-SN-5	5' Satin Nickel Flat Track Kit	
FTST-SN-6	6' Satin Nickel Flat Track Kit	
FTST-SN-8	8' Satin Nickel Flat Track Kit	

Finishes



PART NO.	DESCRIPTION	
FTST-BL-8C	8' Black Flat Track Kit	KITS CONTAIN: Two 4' Tracks (40mm H x 6mm W), Traditional Hangers, Spacers, End Stops, Floor Guides, Anti-Jump Blocks, Track Connector, and all Necessary Fasteners
FTST-OB-8C	8' Oil-Rubbed Bronze Flat Track Kit	
FTST-SS-8C	8' Satin Stainless Flat Track Kit	
FTST-BL-10C	10' Black Flat Track Kit	KITS CONTAIN: Two 5' Tracks (40mm H x 6mm W), Traditional Hangers, Spacers, End Stops, Floor Guides, Anti-Jump Blocks, Track Connector, & all Necessary Fasteners
FTST-SS-10C	10' Satin Stainless Flat Track Kit	
FTST-SN-10C	10' Satin Nickel Flat Track Kit	



See pages 12 and 13 for specifications and additional parts.

TRADITIONAL DROP HANGER

Standard Kits

FLAT TRACK



PART NO.	DESCRIPTION		
FTAT-BL-6	6FT Flat Track with Arched Top Thrubolt Hangers	FT-Series	Black
FTAT-BL-8	8FT Bypass Flat Track with Arched Top Thrubolt	FT-Series	Black
FTAT-BL-10C	10FT Bypass Flat Track with Arched Top Thrubolt	FT-Series	Black
FTAT-SN-6	6FT Flat Track with Arched Top Thrubolt Hangers	FT-Series	Satin Nickel
FTAT-SN-8	8FT Flat Track with Arched Top Thrubolt	FT-Series	Satin Nickel
FTAT-SN-10C	10FT Flat Track with Arched Top Thrubolt	FT-Series	Satin Nickel

- Polymer Wheels for quiet operation
- 200 lbs per Door
- 6', 8' & 10' Options
- For Interior 1-3/8" or 1-3/4" Thick Doors
- All Fasteners Included, including optional connector plate
- Additional Options for: Soft Close & Soft Open, Double Door Applications, & Bypass Applications



- Polymer Wheels for quiet operation
- 200 lbs per Door
- 6'6" and 8' Options
- For Interior 1-3/8" or 1-3/4" Thick Doors Only
- All Fasteners Included, including optional connector plate
- Additional Options for: Soft Close & Soft Open, Double Door Applications, & Bypass Applications

Finishes



PART NO.	DESCRIPTION
FTTM-BL-6-6	6'6" Black Flat Track Kit
FTTM-BL-8	8' Black Flat Track Kit
FTTM-SS-6-6	6'6" Satin Stainless Flat Track Kit
FTTM-SS-8	8' Satin Stainless Flat Track Kit
FTTM-SN-6-6	6'6" Satin Nickel Flat Track Kit
FTTM-SN-8	8' Satin Nickel Flat Track Kit

KITS CONTAIN:
Track (40mm H x 6mm W), Top Mount Hangers, Spacers, End Stops, Floor Guides, Anti-Jump Blocks, Track Connector, and all Necessary Fasteners

PART NO.	DESCRIPTION
FTTM-BL-8C	8' Black Flat Track Kit
FTTM-SS-8C	8' Satin Stainless Flat Track Kit

KITS CONTAIN:
Two 4' Tracks (40mm H x 6mm W), Top Mount Hangers, Spacers, End Stops, Floor Guides, Anti-Jump Blocks, Track Connector, and all Necessary Fasteners

See pages 14 and 15 for specifications and additional parts.

SPOKE WHEEL HANGER

Standard Kits



FLAT TRACK

- Polymer Wheels for quiet operation
- 200 lbs per Door
- 6' and 8' Options
- For Interior 1-3/8" or 1-3/4" Thick Doors
- All Fasteners Included
- Additional Options for: Soft Close & Soft Open & Double Door Applications
- Available only in Black



PART NO.	DESCRIPTION	
FTSK-BL-6	6' Black Spoke Wheel Flat Track Kit	KITS CONTAIN: Track (40mm H x 6mm W), Spoke Wheel Hangers, Spacers, End Stops, Floor Guides, Anti-Jump Blocks, Track Connector, and all Necessary Fasteners
FTSK-BL-8	8' Black Spoke Wheel Flat Track Kit	
FTSK-BL-8C	8' Black Spoke Wheel Flat Track Kit	KITS CONTAIN: Two 4' Tracks (40mm H x 6mm W), Spoke Wheel Hangers, Spacers, End Stops, Floor Guides, Anti-Jump Blocks, Track Connector, and all Necessary Fasteners



See pages 14 and 15 for specifications and additional parts.

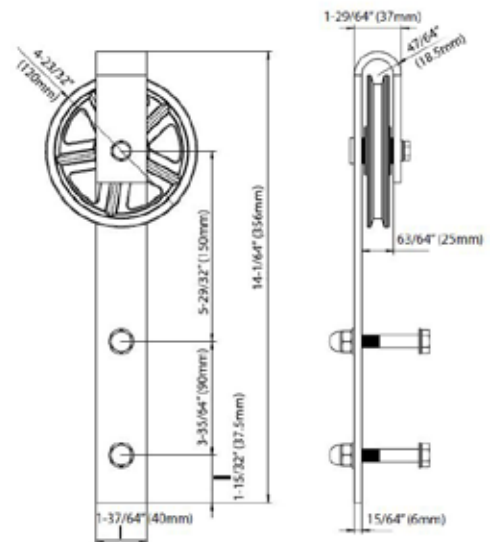



Spear Hanger

- Polymer Wheels for quiet operation
- 200 lbs per Door
- For Interior 1-3/8" or 1 3/4" Thick Doors
- 2 lengths of door bolts included
- Order main track kit separately

PART NO.	FINISH	DESCRIPTION
FTSP-HANGER-BL	Black	Spear Hanger Option for Flat Track
FTSP-HANGER-OB	Oil-Rubbed Bronze	

Horse Shoe Hanger

- Polymer Wheels for quiet operation
- 200 lbs per Door
- For Interior 1-3/8" or 1 3/4" Thick Doors
- 2 lengths of door bolts included
- Order main track kit separately



See pages 14 and 15 for specifications and additional parts.

PART NO.	FINISH	DESCRIPTION
FTHS-HANGER-BL	Black	Horse Shoe Hanger Option for Flat Track
FTHS-HANGER-OB	Oil-Rubbed Bronze	

Order 2 Optional Hangers along with a Standard Kit

Double Door Hanger Kits for Flat Track

Add to a Complete Kit for applications of 2 doors on a single track



PART NO.	DESCRIPTION
FTST-DDK-BL	Black Standard Double Door Hanger Kit
FTST-DDK-OB	Oil-Rubbed bronze Standard Double Door Hanger Kit
FTST-DDK-SN	Satin Nickel Standard Double Door Hanger Kit
FTST-DDK-SS	Stainless Steel Standard Double Door Hanger Kit
FTTM-DDK-BL	Black Top Mount Double Door Hanger Kit
FTTM-DDK-SS	Stainless Steel Top Mount Double Door Hanger Kit
FTSK-DDK-BL	Black Spoke Wheel Double Door Hanger Kit

KITS CONTAIN:
Two Hangers, Two End Stops, Two Floor Guide, Two Anti-Jump Blocks, and all Necessary Fasteners

For double door applications where kits are not available, order hangers, stops, guides, and anti-jump blocks.

Soft-Close & Open

- Closes door quietly and smoothly
- 2 per set, for soft close and soft open

PART NO.	FINISH	DESCRIPTION
FT-SOFTCLOSE-BL	Black	Soft-Close for Flat Track
FT-SOFTCLOSE-GR	Grey	Track (2/set)



Bypass Bracket

- Allows Two Doors to Bypass
- One Bypass Bracket Required for each Spacer

- 5 Brackets for 6' Track
- 5 Brackets for 6'6" Track
- 6 Brackets for 8' Track (8 & 8C)
- 8 Brackets for 10C Track (10C)

PART NO.	FINISH	DESCRIPTION
FTST-BYPASS-BL	Black	Bypass Bracket for Flat Track
FTST-BYPASS-OB	Oil-Rubbed Bronze	
FTST-BYPASS-SS	Satin Stainless	



MFG #	DESCRIPTION	FINISH
FTST-BL-6-BYPASS	6' Bypass Black Flat Track W/ Standard Throbolt	BLACK
FTST-BL-8-BYPASS	8' Bypass Black Flat Track W/ Standard Throbolt	BLACK
FTST-SN-6-BYPASS	6' Bypass Satin Nickel Flat Track W/ Standard Throbolt	SATIN NICKEL
FTST-SN-8-BYPASS	8' Bypass Satin Nickel Flat Track W/ Standard Throbolt	SATIN NICKEL
FTBF-BL-63	Bifold Top Mount Flat Track Kit 63"	BLACK
FTBF-BL-75	Bifold Top Mount Flat Track Kit 72"	BLACK

FTBF Bypass



FT-BL



ROUND STAINLESS STEEL TRACK

Standard Kits

STAINLESS ROUND TRACK



- Polymer Wheels for quiet operation
- 200 lbs per Door
- 6' and 8' Options
- For Interior 1-3/8" or 1-3/4" Thick Doors
- All Fasteners Included
- Quality Boxed Packaging
- Satin Stainless finish only

PART NO.	DESCRIPTION	HANGERS	
RDTM-SS-6	6' Satin Stainless Round Track Kit	Top-Mount Hangers	KITS CONTAINS: Track (25mm Dia x 2mm thick), Hangers, Spacers, End Stops, Floor Guide, and all Necessary Fasteners
RDTM-SS-6	6' Satin Stainless Round Track Kit	Top-Mount Hangers	
RDST-SS-6	6' Satin Stainless Round Track Kit	Drop Hangers	KITS CONTAINS: Track (25mm Dia x 2mm thick), Hangers, Spacers, End Stops, Floor Guide, and all Necessary Fasteners
RDST-SS-8	8' Satin Stainless Round Track Kit		

See pages 12 and 13 for specifications and additional parts.



- Polymer Wheels for quiet operation
- Built-In Soft Close & Open
- 200 lbs per Door
- 6' Option Only in Stainless Steel
- For Interior 1-3/8" or 1-3/4" Thick Doors
- All Fasteners Included

PART NO.	DESCRIPTION	HANGERS	
RDTMDS-SS-6	6' Satin Stainless Round Track with Built In Soft Close	Top Mount w/ Soft Close	KITS CONTAINS: Track (25mm Dia x 2mm thick), Hangers, Spacers, End Stops, Floor Guide, and all Necessary Fasteners

The RDTMDS-SS-6 is only available as a kit. The extra components shown on page 14 are not compatible with this track set.

SLIDING DOOR LOCKS & PULLS

Accessories for Sliding Track

DOOR PULL & LOCKS



AH-RECPULL-6.5



AH-PRIVLATCH



AH-WMADJ-BL



AH-RDPULL

MFG #	DESCRIPTION	FINISH
AH-RDPULL-BL	Round Pull, 1.89" Dia., Pair	Black (Stainless)
AH-RDPULL-SS		Stainless
AH-PRIVLATCH-BL	Privacy Latch for Sliding Doors	Black
AH-PRIVLATCH-SS		Stainless
AH-RECPULL-BL-6.5	Rectangular Pull, 6.5"	Black
AH-RECPULL-SS-6.5		Stainless
AH-RECPULL-BL-8	Rectangular Pull, 8"	Black
AH-RECPULL-SS-8		Stainless
AH-COMBOPULL-SS	12" Round Bar Pull & 8" Recessed Pull Combo	Stainless
AH-COMBOPULL-BL		Black
AH-COMBOSQ-SS	12" Square Bar Pull & 8" Recessed Pull Combo	Stainless
AH-COMBOSQ-BL		Black
AH-BENTPULL-9-BL	9" Overall Length Pull	Black
AH-BENTPULL-12-BL	11.8" Overall Length Pull	Black
AH-ANGLEPULL-6.5-BL	6.4" Overall Length Pull	Black
AH-ANGLEPULL-7.75-BL	7.75" Overall Length Pull	Black
AH-WMADJ-BL	Wall Mounted Door Guide	Black



AH-RECPULL-8



AH-COMBOPULL



AH-COMBOSQ



AH-BENTPULL



AH-ANGLEPULL

COMPONENT PARTS

For Flat Track and Round Stainless



Hangers

FLAT TRACK HANGERS

PART NO.	FINISH	DESCRIPTION
FTST-HANGER-BL	Black	Traditional Drop Hanger Only
FTST-HANGER-OB	Oil-Rubbed Bronze	
FTST-HANGER-SS	Stainless Steel	
FTST-HANGER-SN	Satin Nickel	
FTTM-HANGER-BL	Black	Top Mount Hanger Only
FTTM-HANGER-SS	Satin Stainless	
FTTM-HANGER-SN	Satin Nickel	
FTSK-HANGER-BL	Black	Spoke Wheel Hanger Only

PART NO.	FINISH	DESCRIPTION
FTHS-HANGER-BL	Black	Horseshoe Hanger Only
FTHS-HANGER-OB	Oil-Rubbed Bronze	
FTSP-HANGER-BL	Black	Spear Hanger Only
FTSP-HANGER-OB	Oil-Rubbed Bronze	

ROUND STAINLESS HANGERS

RDTM-HANGER-SS	Stainless Steel	Top Mount Hanger Only
RDST-HANGER-SS	Stainless Steel	Drop Hanger Only

Flat Track Additional Parts

PHOTO	PART NO.	DESCRIPTION
	FTST-STOP-BL	Extra Stops for Flat Track
	FTST-STOP-OB	
	FTST-STOP-SS	
	FTST-STOP-SN	
	FT-GUIDE-BL	Extra Floor Guide, Black
	FT-ADJGD-BL	Adjustable Metal Guide, Black
	FT-METGD	Metal Guide, Black
	FT-BLOCK-BL	Anti-Jump Blocks, Black
	FT-CONNECT-BL	Connector Plate
	FT-CONNECT-OB	
	FT-CONNECT-SS	
	FTSK-STOP-BL	Extra Stop for Spoke Wheel Hanger, Black
	FT-WASHER-6-BL	6 mm Spacer Extender, 6/ Set
	FT-WASHER-6-OB	
	FT-WASHER-6-SS	
	FT-WASHER-6-SN	

Components

PHOTO	PART NO.	DESCRIPTION
	FT-WASHER-14-BL	14 mm Spacer Extender & Lag, 6/Set
	FT-WASHER-14-OB	
	FT-WASHER-14-SS	
	FT-WASHER-14-SN	
	FTST-SPACER-BL	Track Spacer W/ Lag Bolt For 1-3/8 - 1-3/4" Door
	FTST-SPACER-OB	
	FTST-SPACER-SN	
	FTST-SPACER-SS	
	FTSK-SPACER-BL	

Round Track Additional Parts

	RD-CONNECT-SS	Round Track Connector for Combining Tracks, Stainless Steel
	RDST-STOP-SS	Extra Stop for Drop Hangers, Stainless Steel
	RDTML-STOP-SS RDTMR-STOP-SS	Extra Stops for Top Mount Hangers, Stainless Steel
	RD-GUIDE-SS	Extra Floor Guide, Stainless Steel
	RDST-MOUNT-SS	Mounting Bracket for RDTM-SS, Stainless Steel
	RDSTE-MOUNT-SS	Mounting Bracket for RDST-SS, Stainless Steel

SPECIFICATIONS

For Flat Track and Round Stainless

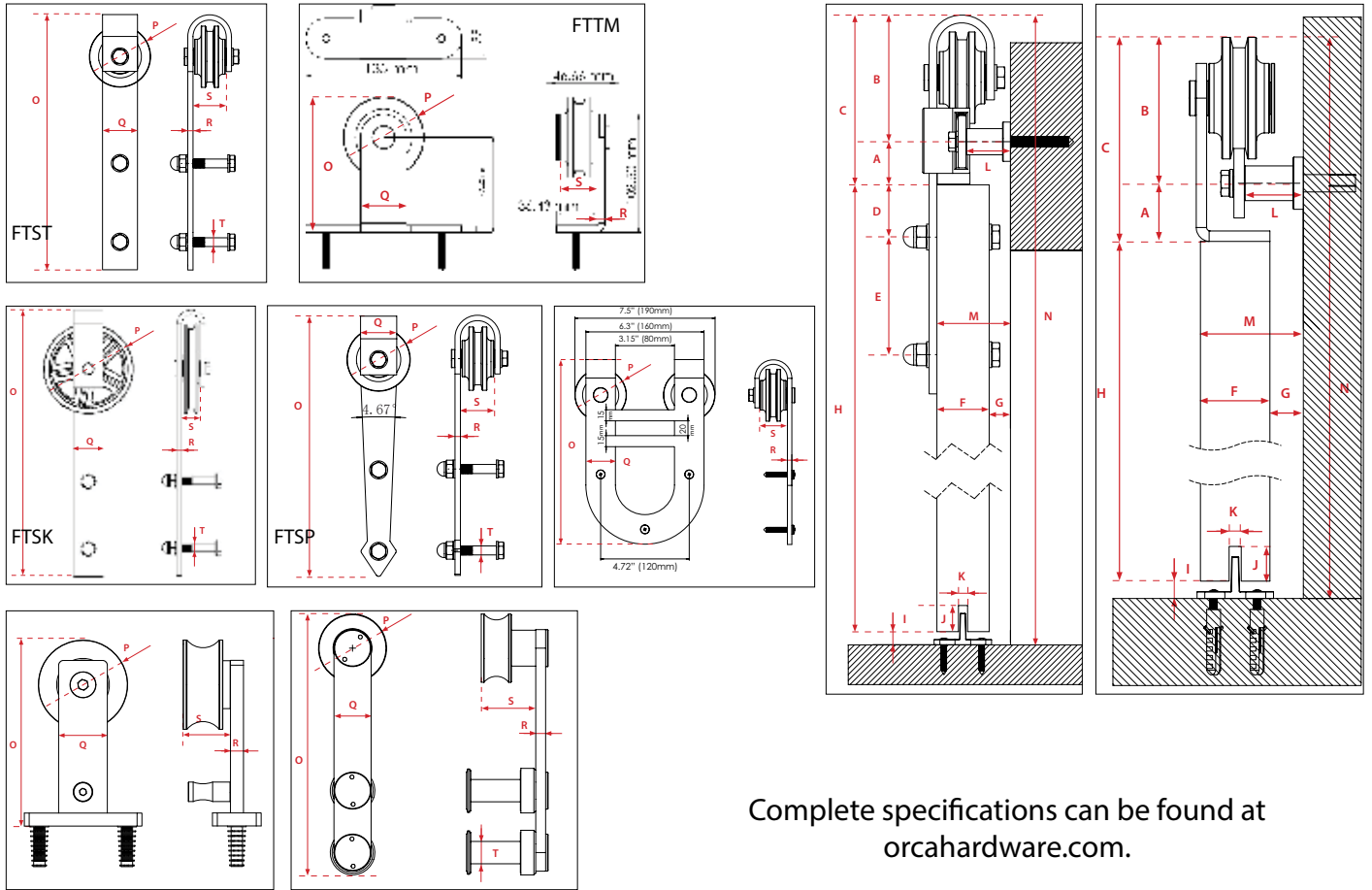

Complete specifications can be found at orcahardware.com.

Measurement	FTST	FTTM	FTSK	FTSP	FTMS	RDTM	RDST
A	1.299" / 33mm	1.319" / 33.5mm	1.299" / 33mm	1.299" / 33mm	1.299" / 33mm	2.047" / 52mm	.984" / 25mm
B	3.858" / 98mm	3.307" / 84mm	6.122" / 155.5mm	3.858" / 98mm	3.858" / 98mm	1.673" / 62.5mm	2.401" / 61.5mm
C	5.157" / 131mm	4.626" / 117.5mm	7.421" / 188.5mm	5.157" / 131mm	5.157" / 131mm	4.508" / 114.5mm	3.405" / 86.5mm
D	1.575" / 40mm	-	1.575" / 40mm	1.575" / 40mm	.965" / 24.5mm	-	2.165" / 55mm
E	3.543" / 90mm	-	3.543" / 90mm	3.543" / 90mm	2.933" / 74.5mm	-	1.968" / 50mm
F	Door Thickness						
G	2.205" - F / 56-F*mm	2.441" - F / 62-F*mm	2.185" - F / 55.5-F*mm	2.205" - F / 56-F*mm	2.205" - F / 56-F*mm	1.53" - F/2 / 38.9-F/2*mm	2.275" - F / 57.8-F*mm
H	Height of Door						
I	.394" / 10mm	.394" / 10mm	.394" / 10mm	.394" / 10mm	.394" / 10mm	.394" / 10mm	.394" / 10mm
J	.787" / 20mm	.787" / 20mm	.787" / 20mm	.787" / 20mm	.787" / 20mm	.787" / 20mm	0.787" / 20mm
K	.275" / 7mm	.275" / 7mm	.275" / 7mm	.275" / 7mm	.275" / 7mm	.275" / 7mm	.275" / 7mm
L	1.338" / 34mm	1.338" / 34mm	1.575" / 40mm	1.338" / 34mm	1.338" / 34mm	.7086" / 18mm	.984" / 25mm
M	2.205" / 56mm	2.441" / 62mm	2.185" / 55.5mm	2.205" / 56mm	2.205" / 56mm	(F/2)+1.53" / (F/2)+38.9mm	1.88" / 2.275" / 47.8 / 57.8^mm
N	H + 5.551" / H+141mm	H + 5.019" / H+127.5mm	H + 7.815" / H+198.5mm	H + 5.551" / H+141mm	H + 5.551" / H+141mm	H + 4.901" / H+124.5mm	H + 3.799" / H+96.5mm
O	11.417" / 290mm	4.626" / 117.5mm	14.0157" / 356mm	11.319" / 287.5mm	9.842" / 250mm	4.508" / 114.5mm	8.287" / 210.5mm
P	2.756" / 70 dia.mm	2.756" / 70 dia.mm	4.724" / 120 dia.mm	2.756" / 70 dia.mm	2.756" / 70 dia.mm	2.165" / 55 dia.mm	2.165" / 55 dia.mm
Q	1.575" / 40mm	1.575" / 40mm	1.575" / 40mm	1.575" / 40mm	1.575" / 40mm	1.181" / 30mm	1.181" / 30mm
R	.236" / 6mm	.236" / 6mm	.236" / 6mm	.236" / 6mm	.236" / 6mm	.315" / 8mm	.315" / 8mm
S	1.496" / 38mm	1.496" / 38mm	.984" / 25mm	1.496" / 38mm	1.496" / 38mm	1.145" / 29.1mm	1.771" / 45mm
T	.394" / 10 dia.mm	-	.394" / 10 dia.mm	.394" / 10 dia.mm	-	-	.708" / 18mm

CABINET FLAT TRACK KIT

Hangers & Hardware to Add a Second Door to a Track



CABINET FLAT TRACK



FTMM-MINI-BL-5



FTSP-MINI-BL-5



FTLO-MINI-SN-5



FTST-MINI-SN-5

COMPLETE KITS

Part Number	Description
FTST-MINI-BL-5	5 FT Black Flat Track with Standard Drop Hangers
FTST-MINI-SN-5	5 FT Satin Nickel Flat Track with Standard Drop Hangers
FTMM-MINI-BL-5	5 FT Black Flat Track with Top Mount Hangers
FTSP-MINI-BL-5	5 FT Black Flat Track with Spear Hangers
FTLO-MINI-BL-5	5 FT Black Flat Track with Long Drop Hangers

GENERAL INFORMATION

<p>APPLICATIONS:</p> <p>Cabinet Sliding Doors or Panels up to 60 lbs.</p> <p>Maximum Door Thickness: 1-3/8"</p> <p>Single door or double door</p>	<p>FINISHES:</p> <p>Single Door Flat Black Satin Nickel (Only available on standard hangers)</p> <p>Double Door Kits Flat Black Satin Nickel (Only available on standard hangers)</p>	<p>Single Door Track Kit includes:</p> <p>5' Track Hangers (2) Spacers End Stops</p> <p>Anti-Jump Blocks All Fasteners Door Guides Instructions</p> <p>Double Door Kit includes:</p> <p>Hangers (2) End Stops Anti-Jump Blocks</p> <p>All Fasteners Door Guides</p>
--	--	---

For information about Orca Hardware's product warranty visit www.orcahardware.com/warranty



FTLO-MINI-BL-5 and
FTLO-MINI-BL-DDK

HOW TO ORDER

Single Door Kits

Hanger Type	Finish	Doors
ST (Std Drop Hanger)	Flat Black	5' (Single Door)
TM (Top Mount)	Satin Nickel	
LO (Long Drop)		
SP (Spear)		

Double Door Applications

ORDER FULL SINGLE DOOR KIT + DOUBLE DOOR KIT

Hanger Type	Finish	Doors
ST (Std Drop Hanger)	Flat Black	DDK (Double Door)
TM (Top Mount)	Satin Nickel	
LO (Long Drop)		
SP (Spear)		

DOUBLE DOOR KITS

FTSP-MINI-BL-5 and
FTSP-MINI-BL-DDK



Part Number	Description
FTST-MINI-BL-DDK	Black Double Door Kit for Standard Drop Hangers
FTST-MINI-SN-DDK	Satin Nickel Double Door Kit for Standard Drop Hangers
FTTM-MINI-BL-DDK	Black Double Door Kit for Top Mount Hangers
FTSP-MINI-BL-DDK	Black Double Door Kit for Spear Hangers
FTLO-MINI-BL-DDK	Black Double Door Kit for Long Drop Hangers

POCKET DOOR HARDWARE

3-Wheel Hangers, 200 lbs Pocket Door Frame Kits



POCKET DOOR HARDWARE



PK1200-BB



POCKET DOOR FRAME COMPLETE KITS FOR THREE FOOT (3') DOORS

Part Number	Description
PK1200-80-BB	6' 8" Pocket Door Frame Kit with 2 Ball Bearing Rollers, 200LB Capacity, for 2x4 Studs
PK1200-84-BB	7' Pocket Door Frame Kit with 2 Ball Bearing Rollers, 200LB Capacity, for 2x4 Studs
PK1200-96-BB	8' Pocket Door Frame Kit with 2 Ball Bearing Rollers, 200LB Capacity, for 2x4 Studs
PK1260-80-BB	6' 8" Pocket Door Frame Kit with 2 Ball Bearing Rollers, 200LB Capacity, for 2x6 Studs
PK1260-84-BB	7' Pocket Door Frame Kit with 2 Ball Bearing Rollers, 200LB Capacity, for 2x6 Studs
PK1260-96-BB	8' Pocket Door Frame Kit with 2 Ball Bearing Rollers, 200LB Capacity, for 2x6 Studs

POCKET DOOR FRAME COMPLETE KITS FOR FOUR FOOT (4') DOORS

Part Number	Description
PK1204-80-BB	6' 8" Pocket Door Frame Kit with 2 Ball Bearing Rollers, 200LB Capacity, for 2x4 Studs
PK1204-84-BB	7' Pocket Door Frame Kit with 2 Ball Bearing Rollers, 200LB Capacity, for 2x4 Studs
PK1204-96-BB	8' Pocket Door Frame Kit with 2 Ball Bearing Rollers, 200LB Capacity, for 2x4 Studs
PK1248-80-BB	6' 8" Pocket Door Frame Kit with 2 Ball Bearing Rollers, 200LB Capacity, for 2x6 Studs
PK1248-84-BB	7' Pocket Door Frame Kit with 2 Ball Bearing Rollers, 200LB Capacity, for 2x6 Studs
PK1248-96-BB	8' Pocket Door Frame Kit with 2 Ball Bearing Rollers, 200LB Capacity, for 2x6 Studs

See pages 27-29 for specifications and additional parts.



PK1200-Track





BULK TRACK AND PARTS

PK1200-TR-48	48" Sliding Door Aluminum Track Only for 1225 Rollers
PK1200-TR-60	60" Sliding Door Aluminum Track Only for 1225 Rollers
PK1200-TR-72	72" Sliding Door Aluminum Track Only for 1225 Rollers
PK1200-TR-96	96" Sliding Door Aluminum Track Only for 1225 Rollers
PK1200-TR-120	120" Aluminum Track Only for 1225 Rollers
PK1200-TR-144	144" Aluminum Track Only for 1225 Rollers
PK1200-TR-192	192" Aluminum Track Only for 1225 Rollers
PK-1225-KIT	Pocket Door Part Set, Triple Wheel Rollers & Hardware, 1" Ball Bearing Wheels, 200LB Capacity
PK-1225-BB	Single Roller Only, Triple Wheel Roller for Pocket Door, 1" Ball Bearing Wheel, 200LB Capacity
PKSC-1216	Soft Close for 1200 Series Track
BF1225-4DR	4 Door Bi-Fold Hardware Pack for PK1200 Track (75 lbs capacity)

1200 SERIES ADDITIONAL COMPONENT PARTS

PART NO.	DESCRIPTION	
PK1211-VERG	Converging Door Kit for 1200 Pocket Door Frame	
PK1212-ADT	Door Adaptor Kit for when using a 1-3/4" Door	
PK1213-ADJGD	Bottom Door Guides	
PK1214-STOP	Mill Stops for Converging Door	

PART NO.	DESCRIPTION	
PK1215-BUMP	Door Bumper	
PK1216-WGU	Wall Mounted Adjustable Door Guide; Plastic	
PK1218-GU	Plastic Floor Guide w/ Screws	
PK1238-SPCR	Spacer Plate for pocket frame when using 1-3/8" Door	

See page 27 for additional parts.

BULK HEAVY DUTY POCKET DOOR HARDWARE



4 Wheel Hangers, 250 lbs Track & Hardware Kits

250 LB. POCKET DOOR

BULK TRACK AND PARTS

Part Number	Description
PK1660	60" Track Only for 4 Wheel Roller
PK1672	72" Track Only for 4 Wheel Roller
PK1696	96" Track Only for 4 Wheel Roller
PK16120	120" Track Only for 4 Wheel Roller
PK16144	144" Track Only for 4 Wheel Roller
PK1625-BB	Hardware Set for Sliding Pocket Door, 4 Wheel Ball Bearing Rollers and Hardware 250LB
PK1620-KIT	4 Wheel Plastic Rollers Set and Hardware (150 lbs)
PKSC1616	Soft Close for 1600 Series Track
PK1615	Black Rubber Stop With Screw
PK1638-DRGD	Door Guide For 1-3/8" Door Thickness
PK1634-DRGD	Door Guide For 1-3/4" Door Thickness



PK1638-DRGD



PK1600 Series Track



PK1625-BB Hardware Set



PKSC1616 Soft Close

See page 27-29 for specifications and additional parts.



BYPASS DOOR HARDWARE KIT 4-WHEEL HANGERS, 250 LBS BYPASS

Part Number	Description
BPK1600-48	48", 250 Lbs. Bypass Door Hardware Kit, 1-3/8" to 1-3/4" Door Thickness
BPK1600-60	60", 250 Lbs. Bypass Door Hardware Kit, 1-3/8" to 1-3/4" Door Thickness
BPK1600-72	72", 250 Lbs. Bypass Door Hardware Kit, 1-3/8" to 1-3/4" Door Thickness



BULK TRACK AND PARTS

Part Number	Description
PK1660	60" Track Only for 4 Wheel Roller
PK1672	72" Track Only for 4 Wheel Roller
PK1696	96" Track Only for 4 Wheel Roller
PK16120	120" A Track Only for 4 Wheel Roller
PK16144	144" Track Only for 4 Wheel Roller



HARDWARE SET FOR SLIDING POCKET DOOR

Part Number	Description
PK-1625-BB	Hardware Set for Sliding Pocket Door, 4 Wheel Ball Bearing Rollers and Hardware 250LB
PK1620-KIT	Hardware Set for Sliding Pocket Door, 4 Wheel Plastic Rollers and Hardware, 150 lbs
PK1218-GU	Plastic Floor Guide With Screws
17-1655	Bypass Track Install Guide, Plastic
PK1614-STOP	4 Wheel Roller Stop



BYPASS DOOR HARDWARE

3-Wheel Hangers, 150 lbs Bypass Kits



150 LB. BYPASS KITS

SLIDING DOOR HARDWARE SETS WITH 3-WHEEL HANGERS

Part Number	Description
BPK1100-48	Contains 2 48" Tracks, 4 3-wheel ball bearing hangers, stops, floor guide, pulls, wrench, fasteners
BPK1100-60	Contains 2 60" Tracks, 4 3-wheel ball bearing hangers, stops, floor guide, pulls, wrench, fasteners
BPK1100-72	Contains 2 72" Tracks, 4 3-wheel ball bearing hangers, stops, floor guide, pulls, wrench, fasteners
BPK1100-96	Contains 2 96" Tracks, 4 3-wheel ball bearing hangers, stops, floor guide, pulls, wrench, fasteners
BPK1100-TR-120	BPK1100 Series 120" Track Only
BPK1100-TR-144	BPK1100 Series 144" Track Only
PK1125-BB	Triple Wheel Roller
BPK1100-3DR	Hardware Pack For Adding 3rd Door To System, Includes (1) Stop, (1) Guide, (1) Angle Stop, (1) Pull, (2) Hangers. Can be used for single door applications when bought with bulk track
BPK1100-4DR	Hardware Pack For Adding 3rd & 4th Door To System, Includes (2) Stops, (1) Guide, (1) Angle Stop, (2) Pulls, (4) Hangers. Can be used for 2 door applications when bought with bulk track
PK1218-GU	Plastic Floor Guide With Screws



BPK1100 Track



Hangers & Stops
(flush pulls, floor guide & fasteners not shown)

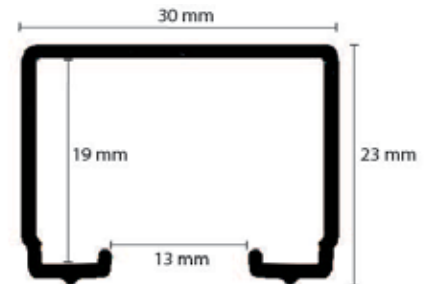

BPK1100
Track Profile

SPECIFICATIONS

- For two (2) Sliding Closet Doors each with a minimum door thickness of 1-3/8" weighing up to 150 lbs. each
- Four (4) 3-wheel hangers - 3/4" wheel diameter

BYPASS DOOR HARDWARE

Track with Fascia, Various Weight Capacities

BYPASS KITS WITH FASCIA

125 LB BYPASS TRACK KITS WITH FASCIA, 3-WHEEL ROLLERS



Part Number	Description
BPK1200F-48	48" Bypass with Fascia Standard Rollers, 1-3/8" Doors
BPK1200F-60	60" Bypass with Fascia Standard Rollers, 1-3/8" Doors
BPK1200F-72	72" Bypass with Fascia Standard Rollers, 1-3/8" Doors
BPK1200F-96	96" Bypass with Fascia Standard Rollers, 1-3/8" Doors

60 LB ALUM. BYPASS KITS W/ FASCIA - SLOT ADJUST HANGERS



BY1300AF-48	48" Aluminum Single Roller Bypass Kit - Small Fascia
BY1300AF-60	60" Aluminum Single Roller Bypass Kit - Small Fascia
BY1300AF-72	72" Aluminum Single Roller Bypass Kit - Small Fascia

60 LB ALUM BYPASS KIT W/ WOOD HEADER



BY1300AH-48	48" Aluminum Bypass Kit with Wood Header
BY1300AH-60	60" Aluminum Bypass Kit with Wood Header
BY1300AH-72	72" Aluminum Bypass Kit with Wood Header

200 LB WALL MOUNT TRACK KITS, 3-WHEEL ROLLERS



WM1200F-60	60" Wall Mount Track With Fascia
WM1200F-72	72" Wall Mount Track With Fascia
WM1200F-96	96" Wall Mount Track With Fascia

BYPASS DOOR HARDWARE

60 lbs Dial-Adjust Hangers



60 LB. DIAL ADJUST BYPASS

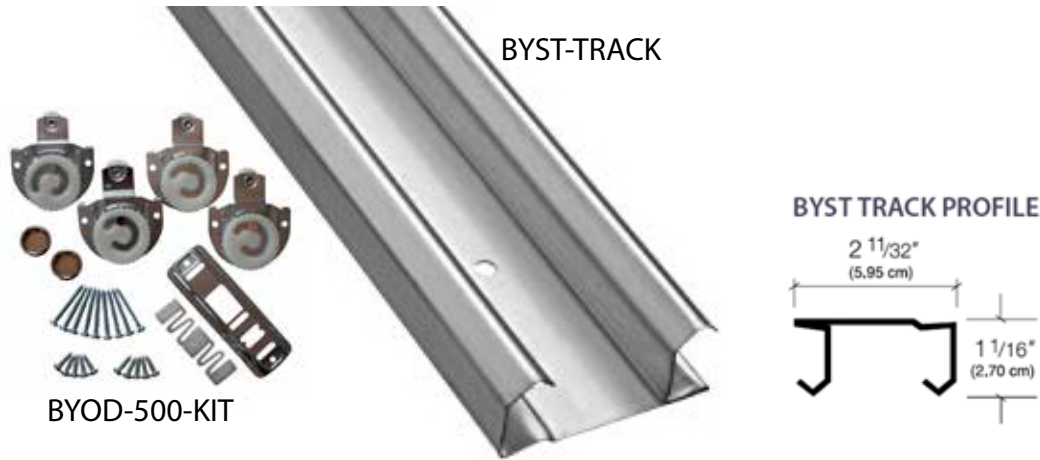

SLIDING DOOR HARDWARE SETS WITH DIAL-ADJUST HANGERS

Part Number	Description
BYST-500-48	48" Bypass Door Hardware Complete Kit Dial-Adjust Offset Dials, 60 lbs
BYST-500-60	60" Bypass Door Hardware Complete Kit Dial-Adjust Offset Dials, 60 lbs
BYST-500-72	72" Bypass Door Hardware Complete Kit Dial-Adjust Offset Dials, 60 lbs
BYST-500-96	96" Bypass Door Hardware Complete Kit Dial-Adjust Offset Dials, 60 lbs

SLIDING DOOR BULK TRACK AND DIAL-ADJUST HANGERS

Used with BYST-(*)-1 Bulk Track. Aluminum track option coming Q3

BYOD-500-KIT	Bypass Door Rollers For 2 Piece Door W/ Floor Guide, 2-7/16" Dials, 2-1/8" Dials
BYOD1-716	Bypass Door Dial-Adjust #1 Hanger Only, Adjustable 7/16"
BYOD2-18	Bypass Door Dial-Adjust #2 Hanger Only, Adjustable 1/8"

SPECIFICATIONS

- For two (2) Sliding Closet Doors each with a thickness of 3/4" to 1-3/8" weighing up to 60 lbs. each
- Four (4) Dial-adjust hangers make it easy to adjust height and align doors without use of special tools. Up to 5/16" vertical door adjustment
- Galvanized Steel V-shaped track is jump proof & resists corrosion See page 29 for additional specification

BYPASS DOOR HARDWARE

60 lbs Slot-Adjust Hangers



BY1000-HDW

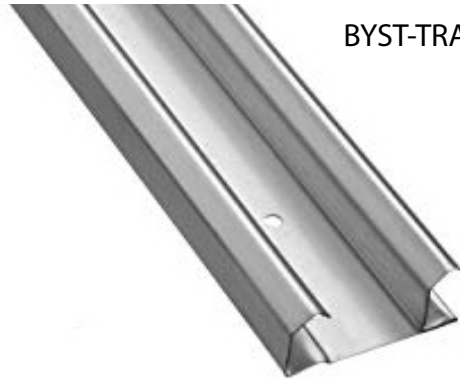

BYST-TRACK



SLIDING DOOR HARDWARE SETS WITH SLOT ADJUST HANGERS

Part Number	Description
BY1300-48	48" Bypass Door Hardware Complete Kit Slot-Adjust Offset Dials, 60 lbs
BY1300-60	60" Bypass Door Hardware Complete Kit Slot-Adjust Offset Dials, 60 lbs
BY1300-72	72" Bypass Door Hardware Complete Kit Slot-Adjust Offset Dials, 60 lbs

SLIDING DOOR BULK TRACK AND SLOT-ADJUST HANGERS

BYST-48-01	48" Bypass Track Only For Either Dial-Adjust or Slot-Adjust Hangers
BYST-60-01	60" Bypass Track Only For Either Dial-Adjust or Slot-Adjust Hangers
BYST-72-01	72" Bypass Track Only For Either Dial-Adjust or Slot-Adjust Hangers
BYST-96-01	96" Bypass Track Only For Either Dial-Adjust or Slot-Adjust Hangers
BYST-120-01	120 Inch Steel Track Only for BYOD-500-KIT or BY1000-HDW
BY1000-HDW	Hardware Kit for BYST Track Contains: 2ea 1/4" Offset Rollers & 2ea 1/2" Offset Rollers, Screws, 2ea Finger Pulls, and Floor Guide
BY1012-HDW	Bypass Hardware Kit for BYST Track, Contains PK1218-GU Floor Guide, 4ea BYSA-12 Single Wheel Roller, & 2 Ea. TH-FPULL-15 Round Flush Pull
BYSA-14	Single Wheel Roller, Hangs on BYST Tracks, Side Hanging, Slot Adjustable, 1/4" Offset, 60Lb Capacity
BYSA-12	Single Wheel Roller, Hangs on BYST Tracks, Side Hanging, Slot Adjustable, 1/2" Offset, 60Lb Capacity

SPECIFICATIONS

- For two (2) Sliding Closet Doors each with a thickness of 3/4" to 1-3/8" weighing up to 60 lbs. each
- Four (4) Adjustable hangers make it easy to adjust height and align doors without use of special tools. Up to 5/16" vertical door adjustment
- Galvanized Steel V-shaped track is jump proof & resists corrosion

See page 29 for additional specification

60 LB. SLOT ADJUST BYPASS

BIFOLD DOOR HARDWARE

Bifold Track Hardware, 30, 75, 125 lbs



BIFOLD TRACK KITS

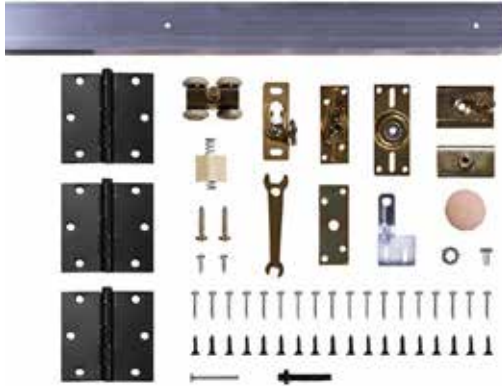

BFK1602



BF3030

125LB PER PANEL BIFOLD SETS

Part Number	Description
BFK1602-36	BB 4 Wheel Bi-Fold Kit for 2 Doors, 36"
BFK1602-48	BB 4 Wheel Bi-Fold Kit for 2 Doors, 48"
BFK1604-48	BB 4 Wheel Bi-Fold Kit for 4 Doors, 48"
BFK1604-60	BB 4 Wheel Bi-Fold Kit for 4 Doors, 60"
BFK1604-72	BB 4 Wheel Bi-Fold Kit for 4 Doors, 72"

75LB PER PANEL BIFOLD HARDWARE

BF1225-4DR	4 Door Bi-Fold Hardware Pack for PK1200 Track (See page 19 for track)
------------	---

30LB PER PANEL BIFOLD TRACK AND HARDWARE

BF3030	30" Bi-Fold Track Only
BF3036	36" Bi-Fold Track Only
BF3048	48" Bi-Fold Track Only
BF3060	60" Bi-Fold Track Only
BF3072	72" Bi-Fold Track Only
BF3002-KIT	2 Door Hardware Bag Set for BF3000 Bi-Fold Track
BF3004-KIT	4 Door Hardware Bag Set for BF3000 Bi-Fold Track

Part Number	Description		
TH-FPULL-10B	Flush Pull	2-1/8" Dia Round Flush Pull, Oil-Rubbed Bronze	
TH-FPULL-15	Flush Pull	2-1/8" Diameter Round Flush Pull, Satin Nickel	
TH-FPULL-26	Flush Pull	2-1/8" Diameter Round Flush Pull, Polished Chrome	
TH-FPULL-26D	Flush Pull	2-1/8" Diameter Round Flush Pull, Satin Chrome	
TH-FPULL-BL	Flush Pull	2-1/8" Diameter Round Flush Pull, Black	
BY-FLGU	Bypass Guide	Adjustable Floor Guide with Metal Bracket	
BY-CPTRSR	Bypass Carpet Riser	By-Pass Door Metal Carpet Riser, Used With BY-FLGU Bypass Guide	
BY-GUIDTR-72	Bottom Channel Guide Track	Aluminum Bottom Channel Guide Track for inserting into floor. Protects floor and provides for smoother travel of the door. Use with BY-BOTGD guide for flush look.	
BY-GUIDTR-96			
BY-GUIDTR-106			
BY-GUIDTR-144			
BY-BOTGD	By-Pass Door Guide	Guide for use with BY-GUIDTR Channel Guide Track	
BP1618-ADGU	HD Adjustable Floor Guide	For doors 1-3/8" to 1-3/4" thick, bypass floor guide for 1600 Series TRack	
BY-CATCH	Multi Door Pull Catch	Multi Door Pull Catch for Bypass Door Configurations. Used in Stacking Door Bypass Systems	
17-1655	Bypass Track Install Guide	Plastic Spacer guide helps align two 1600 series track when installing for 1-3/4" door applications.	
PK1614-STOP	4 Wheel Roller Stop	4 Wheel Roller Stop for use with PK1600 series track and rollers.	
PK1218-GU	Plastic Floor Guide With Screws	Plastic Floor Guide With Screws, 1200	

SPECIFICATIONS

Pocket and Bypass Track Hardware



1200 SERIES SPECS

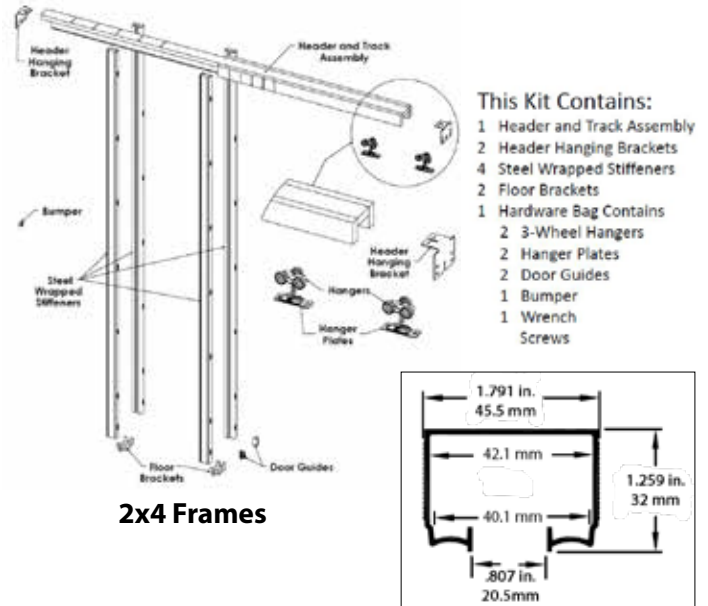
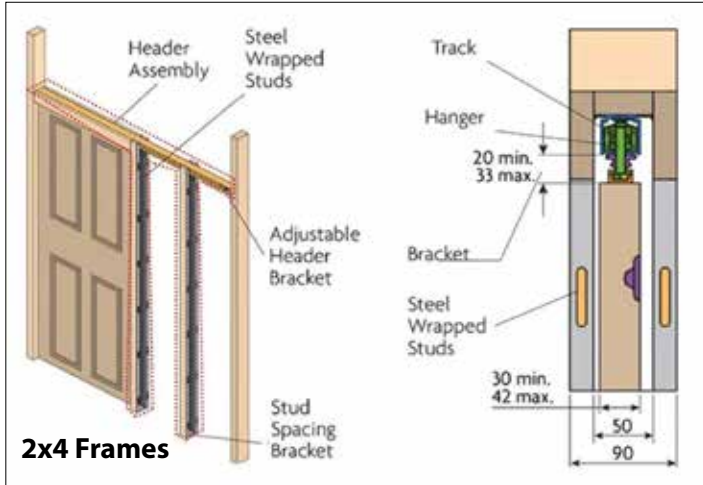

1600 SERIES SPECS

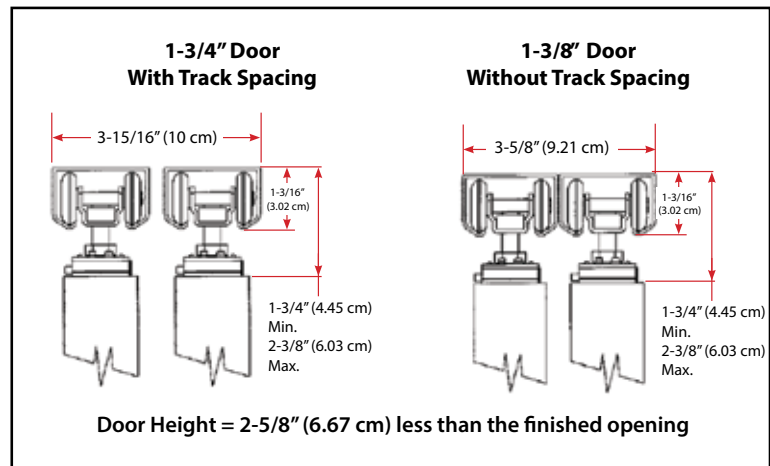
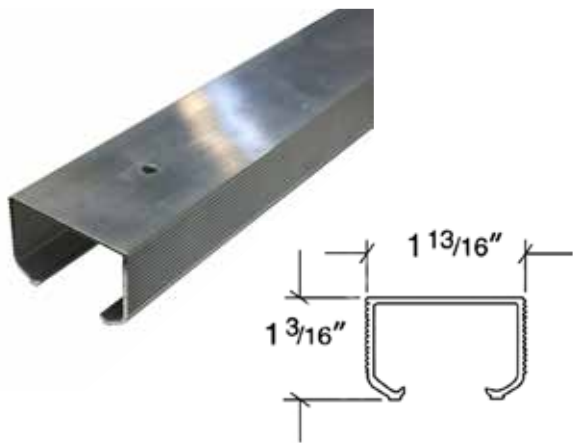

SPECIFICATIONS

- For two (2) Sliding Closet Doors each with a thickness of 3/4" to 1-3/8" weighing up to 60 lbs. each
- Four (4) Dial-adjust hangers make it easy to adjust height and align doors without use of special tools. Up to 5/16" vertical door adjustment
- Galvanized Steel V-shaped track is jump proof & resists corrosion

BYST-500 SERIES SPECS

DIAL ADJUST

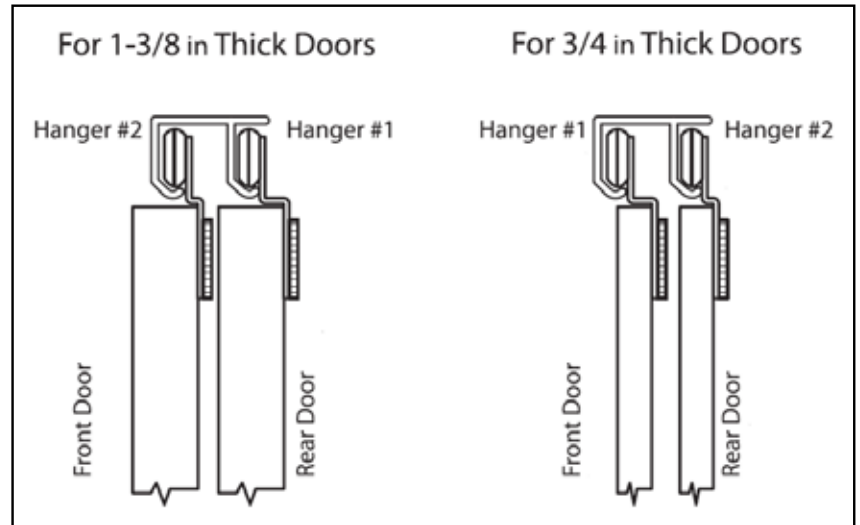

BYST Track is used for both BYST-500 & BY1300 Series

BYST TRACK PROFILE

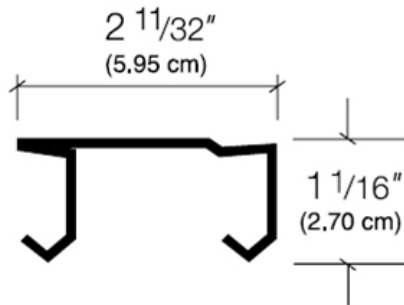

BY1300 SERIES SPECS

SLOT ADJUST

SPECIFICATIONS

- For two (2) Sliding Closet Doors each with a thickness of 3/4" to 1-3/8" weighing up to 60 lbs. each
- Four (4) Adjustable hangers make it easy to adjust height and align doors without use of special tools. Up to 5/16" vertical door adjustment
- Galvanized Steel V-shaped track is jump proof & resists corrosion

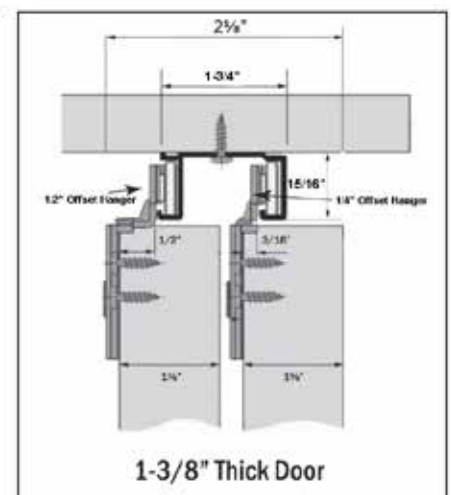
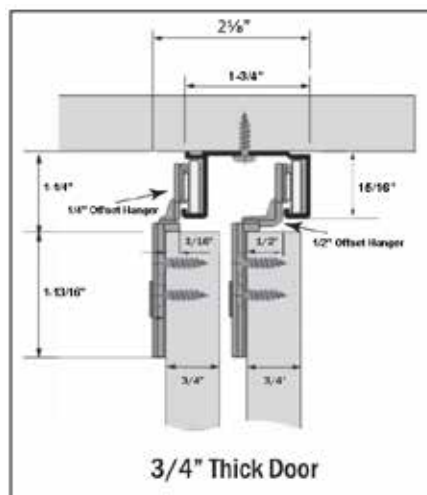

BATHROOM ACCESSORIES



ORCA
HARDWARE™





Part No.	Description	Finish
2718-CH	18" Towel Bar Set	Polished Chrome
2724-CH	24" Towel Bar Set	
2730-CH	30" Towel Bar Set	
2752-CH	Toilet Paper Holder W/ Plastic Tube	
2753-CH	Robe Hook	
2755-CH	Euro T/P Holder	
2760-CH	Towel Ring	



Part No.	Description	Finish
2718-SN	18" Towel Bar Set	Satin Nickel
2724-SN	24" Towel Bar Set	
2730-SN	30" Towel Bar Set	
2752-SN	Toilet Paper Holder W/ Plastic Tube	
2753-SN	Robe Hook	
2755-SN	Euro T/P Holder	
2760-SN	Towel Ring	



Part No.	Description	Finish
2718-ORB	18" Towel Bar Set	Oil-Rubbed Bronze
2724-ORB	24" Towel Bar Set	
2730-ORB	30" Towel Bar Set	
2752-ORB	Toilet Paper Holder W/ Plastic Tube	
2753-ORB	Robe Hook	
2755-ORB	Euro T/P Holder	
2760-ORB	Towel Ring	

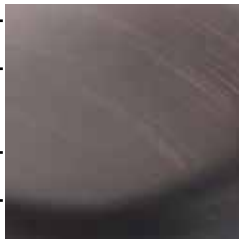

Part No.	Description	Finish
2724-BL	24" Towel Bar Set	Matte Black
2730-BL	30" Towel Bar Set	
2752-BL	Toilet Paper Holder W/ Plastic Tube	
2753-BL	Robe Hook	
2755-BL	Euro T/P Holder	
2760-BL	Towel Ring	



Orca Bath Accessories are polybagged with carded hang tag. 10 each per box.
Cypress rose diameter: 2-1/4"



Part No.	Description	Finish
----------	-------------	--------

9118-CH	18" Towel Bar Set	
9124-CH	24" Towel Bar Set	
9130-CH	30" Towel Bar Set	
9152-CH	Toilet Paper Holder W/ Plastic Tube	
9154-CH	Double Robe Hook	
9155-CH	Euro T/P Holder	
9160-CH	Towel Ring	

9118-SN	18" Towel Bar Set	
9124-SN	24" Towel Bar Set	
9130-SN	30" Towel Bar Set	
9152-SN	Toilet Paper Holder W/ Plastic Tube	
9154-SN	Double Robe Hook	
9155-SN	Euro T/P Holder	
9160-SN	Towel Ring	

9124-SB	24" Towel Bar Set	
9154-SB	Double Robe Hook	
9155-SB	Euro T/P Holder	
9160-SB	Towel Ring	

Part No.	Description	Finish
----------	-------------	--------

9118-ORB	18" Towel Bar Set	
9124-ORB	24" Towel Bar Set	
9130-ORB	30" Towel Bar Set	
9152-ORB	Toilet Paper Holder W/ Plastic Tube	
9154-ORB	Double Robe Hook	
9155-ORB	Euro T/P Holder	
9160-ORB	Towel Ring	

9124-BL	24" Towel Bar Set	
9152-BL	Toilet Paper Holder W/ Plastic Tube	
9154-BL	Double Robe Hook	
9155-BL	Euro T/P Holder	
9160-BL	Towel Ring	

Orca Bath Accessories are polybagged with carded hang tag. 10 each per box.
Waldron rose diameter: 2-3/4"

BLAKELY





Part No.	Description	Finish
4818-CH	18" Towel Bar Set	
4824-CH	24" Towel Bar Set	
4830-CH	30" Towel Bar Set	
4852-CH	Toilet Paper Holder W/ Plastic Tube	
4854-CH	Double Robe Hook	
4855-CH	Euro T/P Holder	
4860-CH	Towel Ring	

Part No.	Description	Finish
----------	-------------	--------

4818-SN	18" Towel Bar Set	
4824-SN	24" Towel Bar Set	
4830-SN	30" Towel Bar Set	
4852-SN	Toilet Paper Holder W/ Plastic Tube	
4854-SN	Double Robe Hook	
4855-SN	Euro T/P Holder	
4860-SN	Towel Ring	

4818-ORB	18" Towel Bar Set	
4824-ORB	24" Towel Bar Set	
4830-ORB	30" Towel Bar Set	
4852-ORB	Toilet Paper Holder W/ Plastic Tube	
4854-ORB	Double Robe Hook	
4855-ORB	Euro T/P Holder	
4860-ORB	Towel Ring	

4824-SB	24" Towel Bar Set	
4852-SB	Toilet Paper Holder W/ Plastic Tube	
4854-SB	Double Robe Hook	
4855-SB	Euro T/P Holder	
4860-SB	Towel Ring	

4824-BL	24" Towel Bar Set	
4852-BL	Toilet Paper Holder W/ Plastic Tube	
4854-BL	Double Robe Hook	
4855-BL	Euro T/P Holder	
4860-BL	Towel Ring	

Orca Bath Accessories are polybagged with carded hang tag. 10 each per box.
Blakely rose diameter: 2-3/4"



Part No.	Description	Finish
----------	-------------	--------

9424-CH	24" Towel Bar Set	Polished Chrome
9452-CH	T/P Holder w/ Tube	
9456-CH	Euro T/P Holder	
9454-CH	Double Robe Hook	
9460-CH	Towel Ring	

Part No.	Description	Finish
----------	-------------	--------

9424-ORB	24" Towel Bar Set	Oil-Rubbed Bronze
9452-ORB	T/P Holder w/ Tube	
9456-ORB	Euro T/P Holder	
9454-ORB	Double Robe Hook	
9460-ORB	Towel Ring	

Part No.	Description	Finish
----------	-------------	--------

9424-SN	24" Towel Bar Set	Satin Nickel
9452-SN	T/P Holder w/ Tube	
9456-SN	Euro T/P Holder	
9454-SN	Double Robe Hook	
9460-SN	Towel Ring	

Part No.	Description	Finish
----------	-------------	--------

9424-BL	24" Towel Bar Set	Matte Black
9452-BL	T/P Holder w/ Tube	
9456-BL	Euro T/P Holder	
9454-BL	Double Robe Hook	
9460-BL	Towel Ring	

Orca Bath Accessories are polybagged with carded hang tag. 10 each per box.
Harstine rose: 1.969" x 1.969



Part No.	Description	Finish
4924-CH	24" Towel Bar Set	
4952-CH	Toilet Paper Holder W/ Plastic Tube	
4954-CH	Double Robe Hook	
4955-CH	Euro T/P Holder	
4960-CH	Towel Ring	



4924-SN	24" Towel Bar Set	
4952-SN	Toilet Paper Holder W/ Plastic Tube	
4954-SN	Double Robe Hook	
4955-SN	Euro T/P Holder	
4960-SN	Towel Ring	

4924-ORB	24" Towel Bar Set	
4952-ORB	Toilet Paper Holder W/ Plastic Tube	
4954-ORB	Double Robe Hook	
4955-ORB	Euro T/P Holder	
4960-ORB	Towel Ring	

4924-BL	24" Towel Bar Set	
4952-BL	Toilet Paper Holder W/ Plastic Tube	
4954-BL	Double Robe Hook	
4955-BL	Euro T/P Holder	
4960-BL	Towel Ring	

Orca Bath Accessories are polybagged with carded hang tag. 10 each per box.
Whidbey rose diameter: 2.87"





Part No.	Description	Finish
3618-CH	18" Chrome Towel Bar	
3624-CH	24" Chrome Towel Bar	
3630-CH	30" Chrome Towel Bar	
3654-CH	Chrome Robe Hook	
3655-CH	Euro T/P Holder	
3661-CH	Towel Ring, Round Ring	
3660-CH	Towel Ring, Rect. Ring	
3618-SN	18" Satin Nickel Towel Bar	
3624-SN	24" Satin Nickel Towel Bar	
3630-SN	30" Satin Nickel Towel Bar	
3654-SN	Satin Nickel Robe Hook	
3655-SN	Euro T/P Holder	
3661-SN	Towel Ring, Round Ring	
3660-SN	Towel Ring, Rect. Ring	
3618-BL	18" Matte Black Towel Bar	
3624-BL	24" Matte Black Towel Bar	
3630-BL	30" Matte Black Towel Bar	
3654-BL	Matte Black Robe Hook	
3655-BL	Euro T/P Holder	
3661-BL	Towel Ring, Round Ring	
3660-BL	Towel Ring, Rect. Ring	

Orca Bath Accessories are polybagged with carded hang tag. 10 each per box.
Swirl rose diameter: 1-3/4"



Part No.	Description	Finish
----------	-------------	--------

3724-CH	24" Chrome Towel Bar	
3752-CH	Toilet Paper Holder W/ Plastic Tube	
3753-CH	Chrome Robe Hook	
3755-CH	Euro T/P Holder	
3756-CH	Curved T/P Holder	
3760-CH	Chrome Towel Ring	

3724-SN	24" Satin Nickel Towel Bar	
3752-SN	Toilet Paper Holder W/ Plastic Tube	
3753-SN	Satin Nickel Robe Hook	
3755-SN	Euro T/P Holder	
3756-SN	Curved T/P Holder	
3760-SN	Satin Nickel Towel Ring	

3724-BL	24" Matte Black Towel Bar	
3752-BL	Toilet Paper Holder W/ Plastic Tube	
3753-BL	Matte Black Robe Hook	
3755-BL	Euro T/P Holder	
3756-BL	Curved T/P Holder	
3760-BL	Matte Black Towel Ring	

Orca Bath Accessories are polybagged with carded hang tag. 10 each per box.
Camano rose dimensions: 2-3/16" diameter



Part No.	Description	Finish
5218-CH	18" Chrome Towel Bar	Polished Chrome 
5224-CH	24" Chrome Towel Bar	
5230-CH	30" Chrome Towel Bar	
5254-CH	Chrome Robe Hook	
5255-CH	Euro T/P Holder	
5260-CH	Chrome Towel Ring	

5218-SN	18" Satin Nickel Towel Bar	Satin Nickel 
5224-SN	24" Satin Nickel Towel Bar	
5230-SN	30" Satin Nickel Towel Bar	
5254-SN	Satin Nickel Robe Hook	
5255-SN	Euro T/P Holder	
5260-SN	Satin Nickel Towel Ring	
5261-SN	Round Towel Ring	

5224-BL	24" Black Towel Bar	Matte Black 
5254-BL	Black Robe Hook	
5255-BL	Euro T/P Holder	
5260-BL	Black Towel Ring	

Orca Bath Accessories are polybagged with carded hang tag. 10 each per box.
Ripple rose dimensions: 1-5/8" x 1-5/8"



Part No.	Description	Finish
5818-CH	18" Towel Bar	Polished Chrome 
5824-CH	24" Towel Bar	
5830-CH	30" Towel Bar	
5854-CH	Robe Hook	
5852-CH	Tis	
5855-CH	Euro T/P Holder	
5856-CH	Curved Euro T/P Holder	
5860-CH	Chrome Towel Ring	

Part No.	Description	Finish
5818-SN	18" Towel Bar	Satin Nickel 
5824-SN	24" Towel Bar	
5830-SN	30" Towel Bar	
5854-SN	Robe Hook	
5855-SN	Euro T/P Holder	
5852-SN	Tissue Holder	
5856-SN	Curved Euro T/P Holder	
5860-SN	Towel Ring	

Part No.	Description	Finish
5824-SB	24" Satin Brass Towel Bar	Satin Brass 
5854-SB	Satin Brass Robe Hook	
5855-SB	Euro T/P Holder	
5856-SB	Curved Euro T/P Holder	
5860-SB	Satin Brass Towel Ring	

Part No.	Description	Finish
5818-BL	18" Towel Bar	Matte Black 
5824-BL	24" Towel Bar	
5830-BL	30" Towel Bar	
5854-BL	Robe Hook	
5852-BL	Tissue Holder	
5855-BL	Euro T/P Holder	
5856-BL	Curved Euro T/P Holder	
5860-BL	Towel Ring	

Orca Bath Accessories are polybagged with carded hang tag. 10 each per box.
Vashon rose dimensions: 2-1/4" x 2-1/4"

SHOWER CURTAIN RODS

STAINLESS STEEL CONSTRUCTION CURVED SHOWER RODS

CSCR50-SS	5' Curved Shower Rod with Holders	Stainless Steel
CSCR50-ORB	5' Curved Shower Rod with Holders	Oil-Rubbed Bronze
CSCR50-CH	5' Curved Shower Rod with Holders	Polished Chrome
CSCR50-BL	5' Curved Shower Rod with Holders	Matte Black
CSCR60-SS	6' Curved Shower Rod with Holders	Stainless Steel
CSCR60-ORB	6' Curved Shower Rod with Holders	Oil-Rubbed Bronze
CSCR60-CH	6' Curved Shower Rod with Holders	Polished Chrome
CSCR60-BL	6' Curved Shower Rod with Holders	Matte Black



STAINLESS STEEL CONSTRUCTED STRAIGHT SHOWER RODS

Part No.	Description	Finish
SSCR50-SS	5' Straight Shower Rod	Stainless Steel
SSCR50-ORB	5' Straight Shower Rod	Oil-Rubbed Bronze
SSCR50-CH	5' Straight Shower Rod	Polished Chrome
SSCR50-BL	5' Straight Shower Rod	Matte Black
SSCR60-SS	6' Straight Shower Rod	Stainless Steel
SSCR60-ORB	6' Straight Shower Rod	Oil-Rubbed Bronze
SSCR60-CH	6' Straight Shower Rod	Polished Chrome
SSCR60-BL	6' Straight Shower Rod	Matte Black



1" Outside Diameter
.025 Thick

SHOWER CURTAIN ROD HOLDERS & GRAB BARS



*For Orca SSR Series Shower Rods
304 Stainless Steel 1.0 mm Thick



STRAIGHT SHOWER ROD HOLDERS

Part No.	Description	Finish
MSRHAD-SN	Metal Rod Holder	Satin Nickel
MSRHAD-ORB	Metal Rod Holder	Oil-Rubbed Bronze
MSRHAD-CH	Metal Rod Holder	Polished Chrome
MSRHAD-BL	Metal Rod Holder	Matte Black
PSRHAD-SN	Plastic Rod Holder	Satin Nickel
PSRHAD-ORB	Plastic Rod Holder	Oil-Rubbed Bronze
PSRHAD-CH	Plastic Rod Holder	Polished Chrome
PSRHAD-BL	Plastic Rod Holder	Matte Black



CONCEALED SCREW METAL SHOWER ROD HOLDERS

SMSRH-SN	Rod Holder Concealed Screws	Satin Nickel
SMSRH-ORB	Rod Holder Concealed Screws	Oil-Rubbed Bronze
SMSRH-CH	Rod Holder Concealed Screws	Polished Chrome
SMSRH-BL	Rod Holder Concealed Screws	Matte Black



EXPOSED SCREW METAL SHOWER ROD HOLDERS

SSRHES-SS	Rod Holder Exposed Screws	Stainless Steel
SSRHES-ORB	Rod Holder Exposed Screws	Oil-Rubbed Bronze
SSRHES-CH	Rod Holder Exposed Screws	Polished Chrome
SSRHES-BL	Rod Holder Exposed Screws	Matte Black

GRAB BARS WITH CONCEALED SCREWS

GB150SS-CS18	18" Long 1.5" O.D. Grab Bar	Stainless Steel
GB150SS-CS24	24" Long 1.5" O.D. Grab Bar	Stainless Steel
GB150SS-CS30	30" Long 1.5" O.D. Grab Bar	Stainless Steel
GB150SS-CS36	36" Long 1.5" O.D. Grab Bar	Stainless Steel
GB150SS-CS42	42" Long 1.5" O.D. Grab Bar	Stainless Steel
GB150SS-CS48	48" Long 1.5" O.D. Grab Bar	Stainless Steel



DOOR HINGES



Finishes



ORCA
HARDWARE®



RESIDENTIAL STEEL HINGES



3.5 x 3.5 HINGES

Standard 1/4 Radius



Part Number	Finish	Corners
RES3514-US2CD	US2CD	R1/4
RES3514-US3	US3	R1/4
RES3514-US3/4	US3/4	R1/4
RES3514-US4	US4	R1/4
RES3514-US5	US5	R1/4
RES3514-US10B	US10B/ORB	R1/4
RES3514-US15	US15/SN	R1/4
RES3514-US26	US26	R1/4
RES3514-US26D	US26D	R1/4
RES3514-US19	US19	R1/4
RES3514-US19E	ELECTROPLATED 19E	R1/4
RES3514-10BE	ELECTROPLATED 10B	R1/4

Ball Bearing 1/4 Radius



RES3514BB-US3	US3	R1/4
RES3514BB-US10B	US10B/ORB	R1/4
RES3514BB-US15	US15/SN	R1/4
RES3514BB-US26	US26	R1/4
RES3514BB-US26D	US26D	R1/4
RES3514BB-US19	US19	R1/4

Standard 5/8 Radius

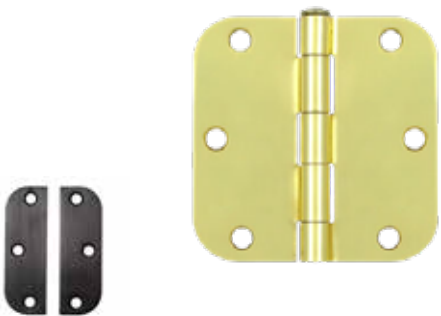

RES3558-US2CD	US2CD	R5/8
RES3558-US3	US3	R5/8
RES3558-US3/4	US3/4	R5/8
RES3558-US4	US4	R5/8
RES3558-US5	US5	R5/8
RES3558-US10B	US10B/ORB	R5/8
RES3558-US15	US15/SN	R5/8
RES3558-US26	US26	R5/8
RES3558-US26D	US26D	R5/8
RES3558-US19	US19	R5/8
RES3558-10BE	ELECTROPLATED 10B	R5/8
RES3558-19E	ELECTROPLATED US19	R5/8
RES3558-32D	BRUSHED STAINLESS STEEL	R5/8
RES3558-WH	WHITE	R5/8

Hinge Prep Filler Plates

w/ #9x3/4 Screws

RES3558CU-10B	US10B/ORB	R5/8
RES3558CU-15	US15/SN	R5/8
RES3558CU-26	US26	R5/8

.091" Gauge for both standard & ball bearing 3.5" Hinges

These hinges come with #9 x 3/4" screws. #9 x 1" screws available upon request. Packed 100 hinges per box.



RESIDENTIAL STEEL HINGES

Part Number	Finish	Corners
RES3558BB-US3	US3	R5/8
RES3558BB-US3/4	US3/4	R5/8
RES3558BB-US10B	US10B/ORB	R5/8
RES3558BB-US15	US15/SN	R5/8
RES3558BB-US26	US26	R5/8
RES3558BB-US26D	US26D	R5/8
RES3558BB-US19	US19	R5/8



**Ball Bearing
5/8 Radius**

4 x 4 HINGES

RES4014-US3	US3	R1/4
RES4014-US34	US3/4	R1/4
RES4014-US5	US5	R1/4
RES4014-US10B	US10B/ORB	R1/4
RES4014-US15	US15/SN	R1/4
RES4014-US26	US26	R1/4
RES4014-US26D	US26D	R1/4
RES4014-US19	US19	R1/4
RES4014-2CD	2CD	R1/4
RES4014-10BE	ELECTROPLATED 10B	R1/4
RES4014-19E	ELECTROPLATED US19	R1/4
RES4014-2CD	BRUSHED ZINC	R1/4

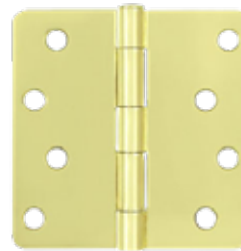

**Standard
1/4 Radius**

RES4014-NRP-US10B	US10B/ORB	R1/4
RES4014-NRP-US15	US15	R1/4
RES4014-NRP-US26	US26	R1/4
RES4014-NRP-US19	US19	R1/4



**NRP Standard
1/4 Radius**

RES4014BB-US3	US3	R1/4
RES4014BB-US10B	US10B/ORB	R1/4
RES4014BB-US15	US15	R1/4
RES4014BB-US26	US26	R1/4
RES4014BB-US26D	US26D	R1/4
RES4014BB-US19	US19	R1/4

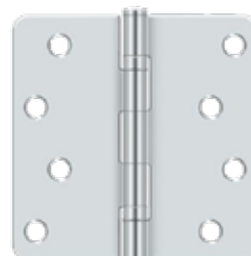

**Ball Bearing
1/4 Radius**

.100" Gauge for both standard & ball bearing 4" Hinges. 4" hinges come standard with 1" screws. Add -3Q suffix to the part number for 3/4" screws.

4 X 4 STEEL HINGES

**4 x 4 Standard
5/8 Radius**



Part Number	Finish	Corners
RES4058-US3	US3	R5/8
RES4058-US34	US3/4	R5/8
RES4058-US5	US5	R5/8
RES4058-US10B	US10B/ORB	R5/8
RES4058-US15	US15/SN	R5/8
RES4058-US26	US26	R5/8
RES4058-US26D	US26D	R5/8
RES4058-US19	US19	R5/8
RES4058-2CD	2CD	R5/8
RES4058-10BE	ELECTROPLATED 10B	R5/8
RES4058-19E	ELECTROPLATED US19	R5/8
RES4058-2CD	BRUSHED ZINC	R5/8
RES4058-32D	BRUSHED STAINLESS STEEL	R5/8

**4 x 4 NRP Standard
5/8 Radius**



RES4058BB-NRP-US3	US3	R5/8
RES4058BB-NRP-US10B	US10B/ORB	R5/8
RES4058BB-NRP-US15	US15/SN	R5/8
RES4058-NRP-US10B	US10B/ORB	R5/8
RES4058-NRP-US15	US15/SN	R5/8
RES4058-NRP-US26D	US26D	R5/8
RES4058-NRP-US19	US19	R5/8
RES4058-NRP-US26	US26	R5/8
RES4058-NRP-2CD	BRUSHED ZINC	R5/8
RES4058-NRP-32D	BRUSHED STAINLESS STEEL	R5/8

**4 x 4 Ball Bearing
5/8 Radius**

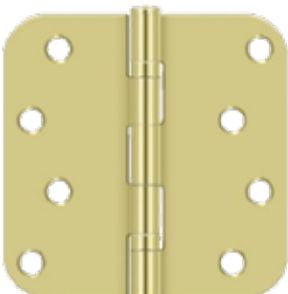

RES4058BB-US3	US3	R5/8
RES4058BB-US5	US5	R5/8
RES4058BB-US10B	US10B/ORB	R5/8
RES4058BB-US15	US15/SN	R5/8
RES4058BB-US26	US26	R5/8
RES4058BB-US26D	US26D	R5/8
RES4058BB-US19	US19	R5/8

.100" Gauge for both standard & ball bearing 4" Hinges. These hinges come with #9 x 1" screws. #9 x 1" screws available upon request. Packed 100 hinges per box. Add -3Q suffix to part number for 3/4" screws

3.5 x 3.5 STEEL HINGES

Part Number	Finish	Corners
COM3514-US3 3.5 X 3.5	US3	R1/4
COM3514-ORB (10B) 3.5 X 3.5	US10B/ORB	R1/4
COM3514-US15 3.5 X 3.5	US15/SN	R1/4
COM3514-US26 3.5 X 3.5	US26	R1/4
COM3514-26D 3.5 X 3.5	US26D	R1/4
COM3514-US19 3.5 X 3.5	US19	R1/4
COM3514-US4 3.5 X 3.5	US4	R1/4
COM3535-US3 3.5 X 3.5	US3	Square
COM3535-ORB (10B) 3.5 X 3.5	US10B/ORB	Square
COM3535-US15 3.5 X 3.5	US15/SN	Square
COM3535-US26 3.5 X 3.5	US26	Square
COM3535-26D 3.5 X 3.5	US26D	Square
COM3535-US19 3.5 X 3.5	US19	Square
COM3535 US4 3.5 X 3.5	US4	Square



4 x 4 STEEL HINGES

COM4040-US3 4 X 4	US3	Square
COM4040-ORB (10B) 4 X 4	US10B/ORB	Square
COM4040-US15 4 X 4	US15/SN	Square
COM4040-26 4 X 4	US26	Square
COM4040-26D 4 X 4	US26D	Square
COM4040-US19 4 X 4	US19	Square
COM4040-US4 4 X 4	US4	Square
COM4014-US3 4 X 4	US3	R1/4
COM4014-ORB (10B) 4 X 4	US10B/ORB	R1/4
COM4014-10DB (Dark 10B) 4 X 4	Dark 10B	R1/4
COM4014-US15 4 X 4	US15/SN	R1/4
COM4014-26 4 X 4	US26	R1/4
COM4014-26D 4 X 4	US26D	R1/4
COM4014-US19 4 X 4	US19	R1/4
COM4014-US19PC 4 X 4	US19PC	R1/4
COM4014-US4 4 X 4	US4	R1/4

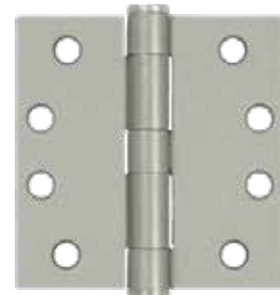

.123" Gauge for standard 3.5" Commercial Hinges .130" Gauge for standard 4" Commercial Hinges
3.5" x 3.5" hinges come with #10 x 1/2" screws and #10 x 1" wood screws.

4" x 4" hinges come with #12 x 1/2" machine screws and #12 x 1-1/4" wood screws.

Packed 48 hinges per box.

4 x 4 STEEL HINGES



Part Number	Finish	Corners
COM4040BB-15 4 X 4 Ball Bearing	US15/SN	Square
COM4040BB-10B 4 X 4 Ball Bearing	US10B/ORB	Square
COM4040BB-19 4 X 4 Ball Bearing	US19	Square
COM4040BB-26D 4 X 4 Ball Bearing	US26D	Square
COM4040BB-26 4 X 4 Ball Bearing	US26	Square
COM4040BB-4 4 X 4 Ball Bearing	US4	Square
COM4014BB-26D 4 X 4 Ball Bearing	US26D	R1/4
COM4014BB-15 4 X 4 Ball Bearing	US15/SN	R1/4
COM4014BB-10B 4 X 4 Ball Bearing	US10B/ORB	R1/4
COM4014BB-19 4 X 4 Ball Bearing	US19	R1/4
COM4014BB-26 4 X 4 Ball Bearing	US26D	R1/4
COM4014BB-4 4 X 4 Ball Bearingw	US4	R1/4

4.5 x 4.5 STEEL HINGES

Part Number	Finish	Corners
COM4545-ORB (10B) 4.5 X 4.5	US10B/ORB	Square
COM4545-26D 4.5 X 4.5	US26D	Square
COM4545-US19 4.5 X 4.5	US19	Square
COM4545BB-ORB (10B) 4.5 X 4.5	US10B/ORB	Square
COM4545BB-ORB (10B) 4.5 X 4.5 NRP	US10B/ORB	Square
COM4545BB-26D 4.5 X 4.5	US26D	Square
COM4545BB-26D 4.5 X 4.5 NRP	US26D	Square
COM4545BB-US19 4.5 X 4.5	US19	Square
COM4545BB-US19 4.5 X 4.5 NRP	US19	Square



HEAVY DUTY 4.5" HINGES

CXD4545BB-10B	US10B/ORB	Square
CXD4545BB-10B-NRP	US10B/ORB	Square
CXD4545BB-19	US19	Square
CXD4545BB-19-NRP	US19	Square
CXD4545BB-26D	US26D	Square
CXD4545BB-26D-NRP	US26D	Square

STAINLESS STEEL 4" AND 4.5" HINGES

SSB4040BB-19-NRP	US19	Square
SSB4040BB-32D-NRP	US32D	Square
SSB4545BB-19-NRP	US19	Square
SSB4545BB-32D-NRP	US32D	Square



.130" Gauge for 4" Commercial Hinges

.134" Gauge for 4.5" Commercial Hinges

4" x 4" hinges come with #12 x 1/2" machine screws and #12 x 1-1/4" wood screws

4.5" x 4.5" hinges come with #12 x 1/2" machine screws and #12 x 1-1/4" wood screws

Packed 48 hinges per box.

3.5 x 3.5 SPRING HINGES



Part Number	Finish	Corners
SPR3535-ORB (10B) 3.5 X 3.5	US10B/ORB	Square
SPR3535-US15 3.5 X 3.5	US15/SN	Square
SPR3535-US19 3.5 X 3.5	US19	Square
SPR3514-ORB (10B) 3.5 X 3.5	US10B/ORB	R1/4
SPR3514-US15 3.5 X 3.5	US15/SN	R1/4
SPR3514-US19 3.5 X 3.5	US19	R1/4
SPR3558-ORB (10B) 3.5 X 3.5	US10B/ORB	R5/8
SPR3558-US15 3.5 X 3.5	US15/SN	R5/8
SPR3558-US19 3.5 X 3.5	US19	R5/8

.106" Gauge for 3.5" Spring Hinge; Supplied with #10 x 1" wood screws and #10 x 1/2" metal screws
 .106" Gauge for 4" Spring Hinge; Supplied with #10 x 1" wood screws and #10 x 1/2" metal screws
 .134" Gauge for 4.5" Spring Hinge; Supplied with #12 x 1-1/4" wood screws and #12 x 1/2" metal screws
 Packet 48 hinges per box

4 x 4 SPRING HINGES



Part Number	Finish	Corners
SPR4040-ORB (10B) 4 X 4	US10B/ORB	Square
SPR4040-US15 4 X 4	US15/SN	Square
SPR4040-26D 4 X 4	US26D	Square
SPR4040-US19 4 X 4	US19	Square
SPR4040-US26 4 X 4	US26	Square
SPR4014-ORB (10B) 4 X 4	US10B/ORB	R1/4
SPR4014-US15 4 X 4	US15/SN	R1/4
SPR4014-26D 4 X 4	US26D	R1/4
SPR4014-US19 4 X 4	US19	R1/4
SPR4014-US26 4 X 4	US26	R1/4
SPR4058-ORB (10B) 4 X 4	US10B/ORB	R5/8
SPR4058-US15 4 X 4	US15/SN	R5/8
SPR4058-26D 4 X 4	US26D	R5/8
SPR4058-US19 4 X 4	US19	R5/8
SPR4058-US26 4 X 4	US26	R5/8

4.5 x 4.5 SPRING HINGES



SPR4545-ORB (10B) 4.5 X 4.5	US10B/ORB	Square
SPR4545-US15 4.5 X 4.5	US15/SN	Square
SPR4545-26D 4.5 X 4.5	US26D	Square
SPR4545-US19 4.5 X 4.5	US19	Square

4 x 4 SPRING HINGES

4" x 4" x 5/8" Radius Corner Spring Hinge, Z Hole Pattern



Part Number	Finish	Corners
SPR4058Z-10B	US10B/ORB	R5/8
SPR4058Z-US15	US15/SN	R5/8
SPR4058Z-US4	US4	R5/8
SPR4058Z-US26	US26	R5/8
SPR4058Z-US19	US19	R5/8
SPR4058Z-WH	White	R5/8

4" x 4" x 1/4" Radius Corner Spring Hinge, Z Hole Pattern



SPR4014Z-10B (10B)	US10B/ORB	R1/4
SPR4014Z-10DB	Dark 10B	R1/4
SPR4014Z-US15	US15/SN	R1/4
SSPR4014Z-US4	US19	R1/4
SPR4014Z-US26	US26	R1/4
SPR4014Z-US19	US19	R1/4

4" x 4" x Square Corner Spring Hinge, Z Hole Pattern



SPR4040Z-10B	US10B/ORB	Square
SPR4040Z-US15	US15/SN	Square
SSPR4040Z-US4	US19	Square
SPR4040Z-US26	US26	Square
SPR4040Z-US19	US19	Square

Residential Hinges

Templates Not To Scale, for reference only.

3.5 Inch x 3.5 Inch
Full Mortise Standard Weight Hinge Template
Full Mortise Ball Bearing Weight Hinge Template

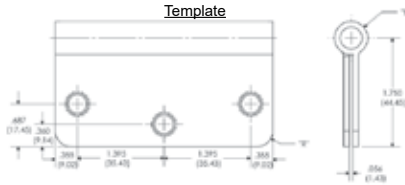

Part Number			Gauge of Metal	"E" Outside Dia.	"L" Leaf Width	"R" Corner Radius
Steel Square	Steel 1/4" Radius	Steel 5/8" Radius				
RES3535	RES3514	RES3558	.091"	.418"	1.75"	Square, 1/4", 5/8"
RES3535BB	RES3514BB	RES3558BB	.091"	.418"	1.75"	Square, 1/4", 5/8"

4 Inch x 4 Inch
Full Mortise Standard Weight Hinge Template
Full Mortise Ball Bearing Weight Hinge Template

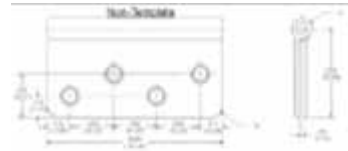

Part Number			Gauge of Metal	"E" Outside Dia.	"L" Leaf Width	"R" Corner Radius
Steel Square	Steel 1/4" Radius	Steel 5/8" Radius				
RES4040	RES4014	RES4058	.100"	.460"	2.00"	Square, 1/4", 5/8"
RES4040BB	RES4014BB	RES4058BB	.100"	.460"	2.00"	Square, 1/4", 5/8"

Commercial Hinges

Templates Not To Scale, for reference only.

3.5 Inch x 3.5 Inch
Full Mortise Standard Weight Hinge

MFG #	Gauge	Outside Dia. "D"	Leaf Width "L"	Swage Line "S"	Corner Radius "R"
COM3535	.123"	.535"	1.75"	1.42"	Square

COM3535 hinges come with #10 x 1/2" machine screws and #10 x 1" wood screws.

4 Inch x 4 Inch
Full Mortise Standard Weight Hinge

MFG #	Gauge	Outside Dia. "D"	Leaf Width "L"	Swage Line "S"	Corner Radius "R"
COM4040	.130"	.550"	2.00"	1.67"	Square

COM4040 hinges come with #12 x 1/2" machine screws and #12 x 1-1/4" wood screws.

4.5 Inch x 4.5 Inch
Full Mortise Standard Weight Hinge

MFG #	Gauge	Outside Dia. "D"	Leaf Width "L"	Swage Line "S"	Corner Radius "R"
COM4545	.134"	.6"	2.25"	1.88"	Square

COM4545 hinges come with #12 x 1/2" machine screws and #12 x 1-1/4" wood screws.

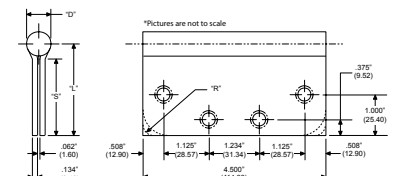
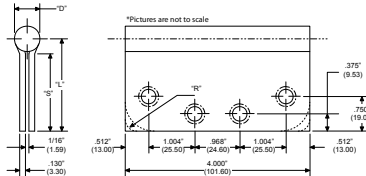
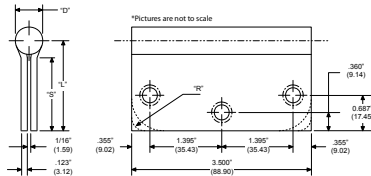

Spring Hinges

Templates Not To Scale, for reference only.

4 Inch x 4 Inch
Full Mortise Standard Weight Hinge

MFG #	Gauge	Outside Dia. "D"	Leaf Width "L"	Swage Line "S"	Corner Radius "R"
SPR4040	.107"	.750"	2.00"	1-1/16"	Square

SPR4040 hinges come with #10 x 1/2" machine screws and #10 x 1" wood screws.

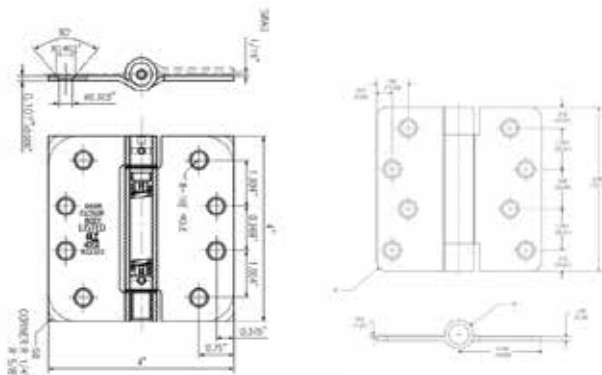

4.5 Inch x 4.5 Inch
Full Mortise Standard Weight Hinge

MFG #	Gauge	Outside Dia. "D"	Leaf Width "L"	Swage Line "S"	Corner Radius "R"
SPR4545	.134"	.750"	2.25"	1-1/16"	Square

SPR4545 hinges come with #12 x 1/2" machine screws and #12 x 1-1/4" wood screws.

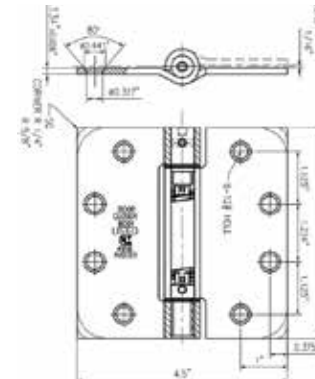

CABINET HARDWARE



ORCA
HARDWARE™



Stainless Steel Bar Pulls

- Solid Stainless Steel
- 12 mm diameter



PART NUMBER	DESCRIPTION	FINISH
CK-10200-SS	Bar T-Pull, Stainless, 2 in. Bar Width	Stainless Steel
CP-10300-SS	Bar Pull, Stainless, 3 in. ctc	Stainless Steel
CP-10096-SS	Bar Pull, Stainless, 96 mm ctc	Stainless Steel
CP-10128-SS	Bar Pull, Stainless, 128 mm ctc	Stainless Steel
CP-10192-SS	Bar Pull, Stainless, 192 mm ctc	Stainless Steel
CP-10256-SS	Bar Pull, Stainless, 256 mm ctc	Stainless Steel



Steel Bar Pulls

- Solid Steel
- 12 mm diameter

PART NUMBER	DESCRIPTION	FINISH
CK-12001-SN	Bar T-Pull, Steel, 2 in. Bar Width	Satin Nickel
CP-12300-SN	Bar Pull, Steel, 3 in. ctc	Satin Nickel
CP-12096-SN	Bar Pull, Steel, 96 mm ctc	Satin Nickel
CP-12128-SN	Bar Pull, Steel, 128 mm ctc	Satin Nickel
CP-12192-SN	Bar Pull, Steel, 192 mm ctc	Satin Nickel
CP-12256-SN	Bar Pull, Steel, 256 mm ctc	Satin Nickel
CK-12001-ORB	Bar T-Pull, Steel, 2 in. Bar Width	Oil-Rubbed Bronze
CP-12300-ORB	Bar Pull, Steel, 3 in. ctc	Oil-Rubbed Bronze
CP-12096-ORB	Bar Pull, Steel, 96 mm ctc	Oil-Rubbed Bronze
CP-12128-ORB	Bar Pull, Steel, 128 mm ctc	Oil-Rubbed Bronze
CK-12001-BL	Bar T-Pull, Steel, 2 in. Bar Width	Matte Black
CP-12300-BL	Bar Pull, Steel, 3 in. ctc	Matte Black
CP-12096-BL	Bar Pull, Steel, 96 mm ctc	Matte Black
CP-12128-BL	Bar Pull, Steel, 128 mm ctc	Matte Black
CK-12001-PC	Bar T-Pull, Steel, 2 in. Bar Width	Polished Chrome
CK-12096-PC	Bar Pull, Steel, 96 mm ctc	Polished Chrome



Blackcomb Collection



PART NUMBER	DESCRIPTION	FINISH
CP-17096-BL	Blackcomb Pull, 96 mm ctc	Matte Black
CP-17128-BL	Blackcomb Pull, 128 mm ctc	Matte Black
CP-17160-BL	Blackcomb Pull, 160 mm ctc	Matte Black
CK-17025-BL	Blackcomb Square Knob, 25 mm dia.	Matte Black



CP-17096-SN	Blackcomb Pull, 96 mm ctc	Satin Nickel
CP-17128-SN	Blackcomb Pull, 128 mm ctc	Satin Nickel
CP-17160-SN	Blackcomb Pull, 160 mm ctc	Satin Nickel
CK-17025-SN	Blackcomb Square Knob, 25 mm dia.	Satin Nickel

CP-17096-RG	Blackcomb Pull, 96 mm ctc	Rose Gold
CK-17025-RG	Blackcomb Square Knob, 25 mm dia.	Rose Gold





Olympus Collection

PART NUMBER	DESCRIPTION	FINISH
CP-21096-SN	Olympus Square Pull, 96 mm ctc	Satin Nickel
CP-21128-SN	Olympus Square Pull, 128 mm ctc	Satin Nickel
CP-21160-SN	Olympus Square Pull, 160 mm ctc	Satin Nickel
CK-21037-SN	Olympus Square Knob 29.8mm	Satin Nickel

CP-21096-BL	Olympus Square Pull, 96 mm ctc	Matte Black
CP-21128-BL	Olympus Square Pull, 128 mm ctc	Matte Black
CP-21160-BL	Olympus Square Pull, 160 mm ctc	Matte Black
CK-21037-BL	Olympus Square Knob 29.8mm	Matte Black

CP-21096-RG	Olympus Square Pull, 96 mm ctc	Rose Gold
CP-21128-RG	Olympus Square Pull, 128 mm ctc	Rose Gold
CP-21160-RG	Olympus Square Pull, 160 mm ctc	Rose Gold
CK-21037-RG	Olympus Square Knob 29.8mm	Rose Gold

CP-21096-ORB	Olympus Square Pull, 96 mm ctc	Oil-Rubbed Bronze
CP-21128-ORB	Olympus Square Pull, 128 mm ctc	Oil-Rubbed Bronze
CP-21160-ORB	Olympus Square Pull, 160 mm ctc	Oil-Rubbed Bronze
CK-21037-ORB	Olympus Square Knob 29.8mm	Oil-Rubbed Bronze



Baker Collection



PART NUMBER	DESCRIPTION	FINISH
CP-20096-SN	Baker Pull, 96 mm ctc	Satin Nickel
CP-20128-SN	Baker Pull, 128 mm ctc	Satin Nickel
CP-20160-SN	Baker Pull, 160 mm ctc	Satin Nickel
CK-20032-SN	Baker Square Knob, 32 mm	Satin Nickel



CP-20096-BL	Baker Pull, 96 mm ctc	Matte Black
CP-20128-BL	Baker Pull, 128 mm ctc	Matte Black
CP-20160-BL	Baker Pull, 160 mm ctc	Matte Black
CK-20032-BL	Baker Square Knob, 32 mm	Matte Black



CP-20096-RG	Baker Pull, 96 mm ctc	Rose Gold
CP-20128-RG	Baker Pull, 128 mm ctc	Rose Gold
CP-20160-RG	Baker Pull, 160 mm ctc	Rose Gold
CK-20032-RG	Baker Square Knob, 32 mm	Rose Gold



CP-20096-ORB	Baker Pull, 96 mm ctc	Oil-Rubbed Bronze
CP-20128-ORB	Baker Pull, 128 mm ctc	Oil-Rubbed Bronze
CP-20160-ORB	Baker Pull, 160 mm ctc	Oil-Rubbed Bronze
CK-20032-ORB	Baker Square Knob, 32 mm	Oil-Rubbed Bronze



Mission Collection

PART NUMBER	DESCRIPTION	FINISH
CP-18096-ORB	Mission Pull, 96 mm ctc	Oil-Rubbed Bronze
CP-18128-ORB	Mission Pull, 128 mm ctc	Oil-Rubbed Bronze
CP-18160-ORB	Mission Pull, 160 mm ctc	Oil-Rubbed Bronze
CK-18032-ORB	Mission Knob, 32 mm dia.	Oil-Rubbed Bronze



CP-18096-BL	Mission Pull, 96 mm ctc	Matte Black
CP-18128-BL	Mission Pull, 128 mm ctc	Matte Black
CP-18160-BL	Mission Pull, 160 mm ctc	Matte Black
CK-18032-BL	Mission Knob, 32 mm dia.	Matte Black



CP-18096-SN	Mission Pull, 96 mm ctc	Satin Nickel
CP-18128-SN	Mission Pull, 128 mm ctc	Satin Nickel
CP-18160-SN	Mission Pull, 160 mm ctc	Satin Nickel
CK-18032-SN	Mission Knob, 32 mm dia.	Satin Nickel



CK-18032-RG	Mission Knob, 32 mm dia.	Rose Gold
-------------	--------------------------	-----------



Tahoma Collection



PART NUMBER	DESCRIPTION	FINISH
CP-23096-BL	Tahoma Pull, 96 mm ctc	Matte Black
CP-23128-BL	Tahoma Pull, 128 mm ctc	Matte Black
CP-23160-BL	Tahoma Pull, 160 mm ctc	Matte Black



CP-23096-SN	Tahoma Pull, 96 mm ctc	Satin Nickel
CP-23128-SN	Tahoma Pull, 128 mm ctc	Satin Nickel
CP-23160-SN	Tahoma Pull, 160 mm ctc	Satin Nickel



CP-23096-RG	Tahoma Pull, 96 mm ctc	Rose Gold
CP-23128-RG	Tahoma Pull, 128 mm ctc	Rose Gold
CP-23160-RG	Tahoma Pull, 160 mm ctc	Rose Gold



CP-23096-ORB	Tahoma Pull, 96 mm ctc	Oil-Rubbed Bronze
CP-23128-ORB	Tahoma Pull, 128 mm ctc	Oil-Rubbed Bronze
CP-23160-ORB	Tahoma Pull, 160 mm ctc	Oil-Rubbed Bronze



Whistler Collection

PART NUMBER	DESCRIPTION	FINISH
CP-19096-SN	Whistler Pull, 96 mm ctc	Satin Nickel
CP-19128-SN	Whistler Pull, 128 mm ctc	Satin Nickel
CP-19160-SN	Whistler Pull, 128 mm ctc	Satin Nickel
CK-19032-SN	Whistler Knob 32 mm	Satin Nickel



CP-19096-BL	Whistler Pull, 96 mm ctc	Matte Black
CP-19128-BL	Whistler Pull, 128 mm ctc	Matte Black
CP-19160-BL	Whistler Pull, 128 mm ctc	Matte Black
CK-19032-BL	Whistler Knob 32 mm	Matte Black



CP-19096-RG	Whistler Pull, 96 mm ctc	Rose Gold
CP-19128-RG	Whistler Pull, 128 mm ctc	Rose Gold
CP-19160-RG	Whistler Pull, 128 mm ctc	Rose Gold
CK-19032-RG	Whistler Knob 32 mm	Rose Gold



CP-19096-ORB	Whistler Pull, 96 mm ctc	Oil-Rubbed Bronze
CP-19128-ORB	Whistler Pull, 128 mm ctc	Oil-Rubbed Bronze
CP-19160-ORB	Whistler Pull, 128 mm ctc	Oil-Rubbed Bronze
CK-19032-ORB	Whistler Knob 32 mm	Oil-Rubbed Bronze





CK-15030

Bachelor Collection Knobs

PART NUMBER	DESCRIPTION	FINISH
CK-14025-SN	Kerri Knob, 25 mm dia.	Satin Nickel



CK-15030-ORB	Round Knob, 1-1/4 in. dia.	Oil-Rubbed Bronze
CK-15030-BL	Round Knob, 1-1/4 in. dia.	Matte Black
CK-15030-SN	Round Knob, 1-1/4 in. dia.	Satin Nickel
CK-15030-SC	Round Knob, 1-1/4 in. dia.	Satin Chrome
CK-15030-PC	Round Knob, 1-1/4 in. dia.	Polished Chrome



CK-39100-SN	Round Knob, 30.2 mm	Satin Nickel
CK-39100-ORB	Round Knob, 30.2 mm	Oil-Rubbed Bronze
CK-39100-PC	Round Knob, 30.2 mm	Polished Chrome



CK-16030-ORB	Round Ring Knob, 1-1/4 in. dia.	Oil-Rubbed Bronze
CK-16030-SN	Round Ring Knob, 1-1/4 in. dia.	Satin Nickel



Bachelor Collection Pulls



PART NUMBER	DESCRIPTION	FINISH
CP-15096-ORB	Preston Pull, 96 mm ctc	Oil-Rubbed Bronze
CP-15096-SN	Preston Pull, 96 mm ctc	Satin Nickel
CP-15096-BL	Preston Pull, 96 mm ctc	Matte Black

CP-44300-SN	Cup Pull, 3" ctc	Satin Nickel
CP-44300-BL	Cup Pull, 3" ctc	Matte Black
CP-44300-ORB	Cup Pull, 3" ctc	Oil-Rubbed Bronze
CP-44300-CH	Cup Pull, 3" ctc	Satin Chrome

Wire Pulls

- Solid Steel
- 8 mm diameter



PART NUMBER	DESCRIPTION	FINISH
CP-13300-SC	Wire Pull, Steel, 3 in. ctc	Satin Chrome
CP-13350-SC	Wire Pull, Steel, 3.5 in. ctc	Satin Chrome
CP-13096-SC	Wire Pull, Steel, 96 mm. ctc	Satin Chrome
CP-13400-SC	Wire Pull, Steel, 4 in. ctc	Satin Chrome

Hinge Pin Stops

PART NUMBER	Description	Finish
TH-HPST-BL	Hinge Pin Stop, w/ Black Tip	Black
TH-HPST-10B	Hinge Pin Stop, w/ Black Tip	Oil-Rubbed Bronze
TH-HPST-15	Hinge Pin Stop, w/ Gray Tip	Satin Nickel
TH-HPST-26	Hinge Pin Stop, w/ Gray Tip	Polished Chrome
TH-HPHD-BL	HD Hinge Pin Stop, w/ Black Tip	Black
TH-HPHD-10B	HD Hinge Pin Stop, w/ Black Tip	Oil-Rubbed Bronze
TH-HPHD-15	HD Hinge Pin Stop, w/ White Tip	Satin Nickel
TH-HPHD-26	HD Hinge Pin Stop, w/ White Tip	Polished Chrome
TH-HPDS-BL	Hinge Pin Door Stop, w/ Black Tip	Black
TH-HPDS-10B	Hinge Pin Door Stop, w/ Black Tip	Oil-Rubbed Bronze
TH-HPDS-15	Hinge Pin Door Stop, w/ Gray Tip	Satin Nickel
TH-HPDS-26	Hinge Pin Door Stop, w/ Gray Tip	Polished Chrome
TH-HPDS-26D	Hinge Pin Door Stop, w/ Gray Tip	Brushed Chrome
TH-HPXD-BL	XD Hinge Pin Stop, with Black Tip	Black
TH-HPXD-10B	XD Hinge Pin Stop, with Black Tip	Oil-Rubbed Bronze
TH-HPXD-15	XD Hinge Pin Stop, with Black Tip	Satin Nickel
TH-HPXD-26	XD Hinge Pin Stop, with Black Tip	Polished Chrome



TH-HPST



TH-HPHD



TH-HPDS



TH-HPXD

Add "-WT" to end of part number to designate white tip.

Zinc Alloy

Polybagged, 100/box for TH-HPST & TH-HPHD. 50/box for THHPDS.

Spring Stops



TH-3118



TH-3134

Zinc Alloy
Polybagged, 100/box

PART NUMBER	Description	Finish
TH-3118-BL	Spring Stop, 3-1/8 In., w/ Black Tip	Black
TH-3118-10B	Spring Stop, 3-1/8 In., w/ Black Tip	Oil-Rubbed Bronze
TH-3118-15	Spring Stop, 3-1/8 In., w/ Gray Tip	Satin Nickel
TH-3118-15A	Spring Stop, 3-1/8 In., w/ Gray Tip	Antique Nickel
TH-3118-26	Spring Stop, 3-1/8 In., w/ Gray Tip	Polished Chrome
TH-3118-26D	Spring Stop, 3-1/8 In., w/ Gray Tip	Brushed Chrome
TH-3118-WHT-WH	Spring Stop, 3-1/8 In., w/ White Tip	White
TH-3134-BL	Spring Stop, 3-3/4 In., w/ Black Tip	Black
TH-3134-10B	Spring Stop, 3-3/4 In., w/ Black Tip	Oil-Rubbed Bronze
TH-3134-US15	Spring Stop, 3-3/4 In., w/ Gray Tip	Satin Nickel
TH-3134-26	Spring Stop, 3-3/4 In., w/ Gray Tip	Polished Chrome

Most door stops are available with white bumpers.
Add "-WT" to end of part number to designate white tip.

Solid Stops, 3"



TH-30HD



DSR-30Z



TH-30RD

PART NUMBER	Description	Finish
TH-30HD-BL	Rigid Door Stop, Brass, w/ Black Tip	Black
TH-30HD-10B	Rigid Door Stop, Brass, w/ Black Tip	Oil-Rubbed Bronze
TH-30HD-US15	Rigid Door Stop, Brass, w/ Gray Tip	Satin Nickel
TH-30HD-26	Rigid Door Stop, Brass, w/ Gray Tip	Polished Chrome
DSR-30Z-BL	Rigid Door Stop, Zinc, w/ Black Tip	Black
DSR-30Z-10B	Rigid Door Stop, Zinc, w/ Black Tip	Oil-Rubbed Bronze
DSR-30Z-US15	Rigid Door Stop, Zinc, w/ Gray Tip	Satin Nickel
DSR-30Z-26	Rigid Door Stop, Zinc, w/ Gray Tip	Polished Chrome
DSR-30Z-26D	Rigid Door Stop, Zinc, w/ Gray Tip	Brushed Chrome
TH-30RD-15	Rigid Door Stop, Zinc, w/ Gray Tip	Satin Nickel
TH-30RD-26	Rigid Door Stop, Zinc, w/ Gray Tip	Polished Chrome
TH-30RD-10B	Rigid Door Stop, Zinc, w/ Black Tip	Oil-Rubbed Bronze
TH-30RD-19	Rigid Door Stop, Zinc, w/ Black Tip	Matte Black

Most door stops are available with white bumpers. Add "-WT" to end of part number to designate white tip.

Wall Stops

PART NUMBER	Description	Finish
TH-WSCV-15	Dome Wall Stop Concave	Satin Nickel
TH-WSCV-10B	Dome Wall Stop Concave	Oil-Rubbed Bronze
TH-WSCV-BL	Dome Wall Stop Concave	Black
TH-WSCV-26	Dome Wall Stop Concave	Polished Chrome
TH-WSCV-26D	Dome Wall Stop Concave	Brushed Chrome
TH-WSCX-15	Dome Wall Stop Concave	Satin Nickel
TH-WSCX-10B	Dome Wall Stop Concave	Oil-Rubbed Bronze
TH-WSCX-BL	Dome Wall Stop Concave	Black
TH-WSCX-26	Dome Wall Stop Concave	Polished Chrome
TH-WSCX-26D	Dome Wall Stop Concave	Brushed Chrome



Floor Stops & Kick Down Holders

PART NUMBER	Description	Finish
TH-23LP-15	Floor Dome Stop, Low Rise w/ Gray Tip	Satin Nickel
TH-23LP-10B	Floor Dome Stop, Low Rise, w/ Black Tip	Oil-Rubbed Bronze
TH-23LP-26D	Floor Dome Stop, Low Rise w/ Gray Tip	Brushed Chrome
TH-22HD-10B	Floor Goose Neck, w/ Black Tip	Oil-Rubbed Bronze
TH-22HD-26D	Floor Goose Neck, w/Gray Tip	Brushed Chrome
TH-40ST-15	Kick Down Stop, 5.275" w/ Gray Tip	Satin Nickel
TH-40ST-10B	Kick Down Stop, 5.275" w/ Black Tip	Oil-Rubbed Bronze
TH-40ST-26D	Kick Down Stop, 5.275" w/ Black Tip	Brushed Chrome



TH-23LP



TH-22HD



TH-40ST

Dome & Goose Neck Stop: Brass
Kick Down Stop: Zinc Alloy

Ball and Roller Catches

PART NUMBER	Description	Finish
TH-70DR-15	Ball Catch, Drive In Style	Satin Nickel
TH-70DR-26		Polished Chrome
TH-70DR-BL		Black
TH-70DR-10B		Oil-Rubbed Bronze



TH-70DR

TH-70RC-15	Ball Catch, Radius Corner Faceplate	Satin Nickel
TH-70RC-26		Polished Chrome
TH-70RC-BL		Black
TH-70RC-10B		Oil-Rubbed Bronze
TH-70SC-15		Satin Nickel
TH-70SC-26		Polished Chrome
TH-70SC-BL		Black
TH-70SC-10B		Oil-Rubbed Bronze



TH-RC1HD-15	Heavy Duty Roller Catch Adjustable Nylon Roller with Square Heavy Duty Cast	Satin Nickel
TH-RC1HD-26		Polished Chrome
TH-RC1HD-BL		Black
TH-RC1HD-10B		Oil-Rubbed Bronze



TH-RC2SD-15	Standard Duty Adjustable Roller Catch	Satin Nickel
TH-RC2SD-26		Polished Chrome
TH-RC2SD-BL		Black
TH-RC2SD-10B		Oil-Rubbed Bronze



TH-RC3LC-2C	Utility Roller Catch	Zinc
-------------	----------------------	------



Zinc Alloy + Steel
Polybagged, 50 per box

Flush Pulls

PART NUMBER	Description	Finish
TH-FPULL-15	2-1/8" Round Flush Pull	Satin Nickel
TH-FPULL-ORB		Oil-Rubbed Bronze
TH-FPULL-26		Polished Chrome
TH-FPULL-26D		Brushed Chrome
TH-FPULL-BL		Black



TH-FPREC-15	Rectangular Flush Pull, 3-5/8" x 1-13/16" x 5/8"	Satin Nickel
TH-FPREC-10B		Oil-Rubbed Bronze
TH-FPREC-BL		Black
TH-FPREC-26		Polished Chrome



Finger Pulls

PART NUMBER	Description	Finish
PK1217-FPSN	3/4" Finger Pulls for Bypass Doors, 2 per polybag	Satin Nickel
PK1217-FPORB		Oil-Rubbed Bronze
PK1217-FPBL		Black



Pocket Door Locks

PART NUMBER	Description	Finish
TH-SQPK-S-15	Pocket Door Passage Lock	Satin Nickel
TH-SQPK-S-10B	Pocket Door Passage Lock	Oil-Rubbed Bronze
TH-SQPK-S-26	Pocket Door Passage Lock	Polished Chrome
TH-SQPK-S-BL	Pocket Door Passage Lock	Black
TH-SQPK-V-15	Pocket Door Privacy Lock	Satin Nickel
TH-SQPK-V-10B	Pocket Door Privacy Lock	Oil-Rubbed Bronze
TH-SQPK-V-26	Pocket Door Privacy Lock	Polished Chrome
TH-SQPK-V-BL	Pocket Door Privacy Lock	Black



Brass
 2-3/4" x 2-1/2" x 1-3/8"
 Polybagged, 10 per box

PART NUMBER	Description	Finish
PDLRD-PS-15	Round Passage Pocket Door Lock 1 3/8" to 2 1/8" Door	Satin Nickel
PDLRD-PS-26	Round Passage Pocket Door Lock 1 3/8" to 2 1/8" Door	Polished Chrome
PDLRD-PS-19	Round Passage Pocket Door Lock 1 3/8" to 2 1/8" Door	Black
PDLRD-PS-10B	Round Passage Pocket Door Lock 1 3/8" to 2 1/8" Door	Oil-Rubbed Bronze
PDLRD-PR-15	Pocket Door Privacy Lock, Round	Satin Nickel
PDLRD-PR-26	Pocket Door Privacy Lock, Round	Polished Chrome
PDLRD-PR-19	Pocket Door Privacy Lock, Round	Matte Black
PDLRD-PR-10B	Pocket Door Privacy Lock, Round	Oil-Rubbed Bronze



Pocket Door Locks

PART NUMBER	Description	Finish
PDLSQ-PS-15	Pocket Door Passage Lock Square 1-3/8" to 2-1/8" thick doors	Satin Nickel
PDLSQ-PS-26		Polished Chrome
PDLSQ-PS-19		Black
PDLSQ-PS-10B		Oil-Rubbed Bronze
PDLSQ-PR-15	Pocket Door Privacy Lock Square 1-3/8" to 2-1/8" thick doors	Satin Nickel
PDLSQ-PR-26		Polished Chrome
PDLSQ-PR-19		Matte Black
PDLSQ-PR-10B		Oil-Rubbed Bronze
PDKSQ-EN-15	Keyed Pocket Door Lock Square 1-3/8" to 2-1/8" thick doors	Satin Nickel
PDKSQ-EN-26		Polished Chrome
PDKSQ-EN-19		Black
PDKSQ-EN-10B		Oil-Rubbed Bronze



PDLSQ-PS



PDLRD-PS



PDSQ-EN

DOOR TRIM & ACCESSORIES

Door Viewers

9/16" DOOR PREP



TH-DV180-15	180 Degree Door Viewer	Satin Nickel
TH-DV180-26		Polished Chrome
TH-DV180-BL		Black
TH-DV180-10B		Oil-Rubbed Bronze
TH-DV180UL-15	180 Degree UL Door Viewer	Satin Nickel
TH-DV180UL-26		Polished Chrome
TH-DV180UL-BL		Black
TH-DV180UL-10B		Oil-Rubbed Bronze
TH-DV200UL-15	200 Degree UL Door Viewer	Satin Nickel
TH-DV200UL-26		Polished Chrome
TH-DV200UL-26D		Brushed Chrome
TH-DV200UL-BL		Black
TH-DV200UL-10B		Oil-Rubbed Bronze



1/2" DOOR PREP



TH-DV182-15	180 Degree Door Viewer	Satin Nickel
TH-DV182-26		Polished Chrome
TH-DV182-26D		Brushed Chrome
TH-DV182-BL		Black
TH-DV182-10B		Oil-Rubbed Bronze

Crash Chain

TH-SSCCHV	Single Spring Crash Chain Stop with Vinyl Cover
-----------	---



Flush Bolts with Radius Corner

PART NUMBER	Description	Finish
TH-FBRC6-BL	Flush Bolt, Radius Corner, 6 Inch	Black
TH-FBRC6-15	Flush Bolt, Radius Corner, 6 Inch	Satin Nickel
TH-FBRC6-10B	Flush Bolt, Radius Corner, 6 Inch	Oil-Rubbed Bronze
TH-FBRC6-26	Flush Bolt, Radius Corner, 6 Inch	Polished Chrome
TH-FB2RC6-BL	Flush Bolt, 2 Radius Corners, 6 Inch	Flat Black Coated
TH-FB2RC6-10B	Flush Bolt, 2 Radius Corners, 6 Inch	Oil-Rubbed Bronze
TH-FB2RC6-15	Flush Bolt, 2 Radius Corners, 6 Inch	Satin Nickel
TH-FB2RC6-26	Flush Bolt, 2 Radius Corners, 6 Inch	Polished Chrome



TH-FBRC6



TH-FB2RC6

Surface Bolts



PART NUMBER	Description	Finish
TH-SB6CS-10B	6" Surface Bolt; Brass; with Screws & Accessories	Oil-Rubbed Bronze
TH-SB6CS-19	6" Surface Bolt; Brass; with Screws & Accessories	Flat Black Coated
TH-SB6CS-26	6" Surface Bolt; Brass; with Screws & Accessories	Polished Chrome
TH-SB6CS-15	6" Surface Bolt; Brass; with Screws & Accessories	Satin Nickel
TH-SB6CS-26D	6" Surface Bolt; Brass; with Screws & Accessories	Brushed Chrome
TH-SB12CS-10B	12" Surface Bolt; Brass; with Screws & Accessories	Oil-Rubbed Bronze
TH-SB12CS-19	12" Surface Bolt; Brass; with Screws & Accessories	Flat Black Coated
TH-SB12CS-26	12" Surface Bolt; Brass; with Screws & Accessories	Polished Chrome
TH-SB12CS-15	12" Surface Bolt; Brass; with Screws & Accessories	Satin Nickel
TH-SB12CS-26D	12" Surface Bolt; Brass; with Screws & Accessories	Brushed Chrome

18" Extension Flush Bolts



PART NUMBER	Description	Finish
TH-FBEXRC18-10B	18" x 7-3/8" Extension Flush Bolt; Brass; with Screws	Oil-Rubbed Bronze
TH-FBEXRC18-BL	18" x 7-3/8" Extension Flush Bolt; Brass; with Screws	Flat Black Coated
TH-FBEXRC18-26	18" x 7-3/8" Extension Flush Bolt; Brass; with Screws	Polished Chrome
TH-FBEXRC18-15	18" x 7-3/8" Extension Flush Bolt; Brass; with Screws	Satin Nickel
TH-FBEXRC18-26D	18" x 7-3/8" Extension Flush Bolt; Brass; with Screws	Brushed Chrome

Handrail Brackets

PART NUMBER	Description	Finish
TH-10ST-BL	Handrail Bracket	Black
TH-10ST-10B	Handrail Bracket	Oil-Rubbed Bronze
TH-10ST-US15	Handrail Bracket	Satin Nickel
TH-10ST-26	Handrail Bracket	Polished Chrome
TH-10HD-BL	HD Handrail Bracket	Black
TH-10HD-10B	HD Handrail Bracket	Oil-Rubbed Bronze
TH-10HD-US15	HD Handrail Bracket	Satin Nickel
TH-10HD-26	HD Handrail Bracket	Polished Chrome
TH-10HD-26D	HD Handrail Bracket	Brushed Chrome
TH-10RD-15	Handrail Bracket - Regular Duty	Satin Nickel
TH-10RD-26	Handrail Bracket - Regular Duty	Polished Chrome
TH-10RD-10B	Handrail Bracket - Regular Duty	Oil-Rubbed Bronze
TH-10RD-19	Handrail Bracket - Regular Duty	Flat Black Coated
TH-10TRLG-15	Large Traditional Handrail Bracket	Satin Nickel
TH-10TRLG-BL	Large Traditional Handrail Bracket	Black
TH-10XL-BL	HD Handrail Bracket, Round Base	Black
TH-10XL-10B	HD Handrail Bracket, Round Base	Oil-Rubbed Bronze
TH-10XL-US15	HD Handrail Bracket, Round Base	Satin Nickel
TH-10XL-26	HD Handrail Bracket, Round Base	Polished Chrome
TH-10XL-26D	HD Handrail Bracket, Round Base	Brushed Chrome

TH-10ST



TH-10HD



TH-10RD



TH-10TLRG



TH-10XL



Handrail Brackets: Zinc Alloy Polybagged. Standard: 50/box. Round: 10/box.

Shelf Brackets, Closet Rod



PART NUMBER	Description	Finish
ASRBW-1025	White Adjustable Shelf & Rod Bracket	White
ASBW-1025	White Adjustable Shelf Bracket	White
LSBW-1012	Fixed 10 x 12 inch Shelf Bracket	White
PSPW-WHT	White Plastic Pole Socket Set	White
PSWD-185OD	Wood Closet Pole Socket Set	N/A
PSMC-WHT	White Metal Pole Socket Set	White
PSMC-BLK	Black Metal Pole Socket Set	Black
PSMC-CHR	Chrome Metal Pole Socket	Chrome
OCR08-BL	8 Ft Oval Black Closet Rod	Black
OCRH-BL	Oval End Support for Oval Rod	Black

ORCA
HARDWARE™



orcahardware.com